

X32028XM/Y32028XM + K167398/K167397

TIMKEN

Tapered roller bearings

TYPE: Roller bearings, Tapered, Tapered roller bearing assembly, Type 2TS-IM (X-mounting), two single row bearing with inner and outer distance rings

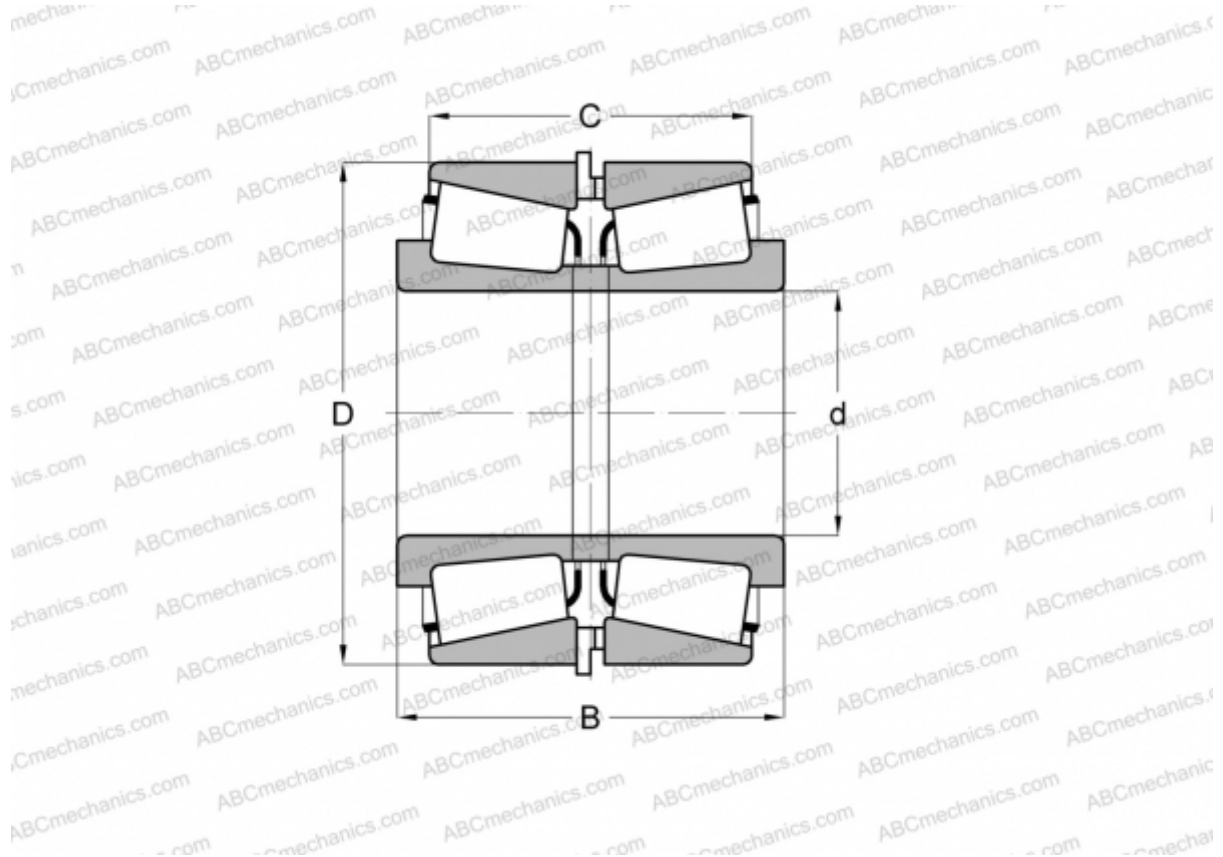

Technical specification

DIMENSIONS, MM

d	140,000
D	210,000
B	98,000
C	76,000

WEIGHT, KG 11,040

MANUFACTURER [TIMKEN](#)