

36690/36626 + X4S-36690/Y1S-36626

TIMKEN

Tapered roller bearings

TYPE: Roller bearings, Tapered, Tapered roller bearing assembly, Type 2TS-IM (X-mounting), two single row bearing with inner and outer distance rings

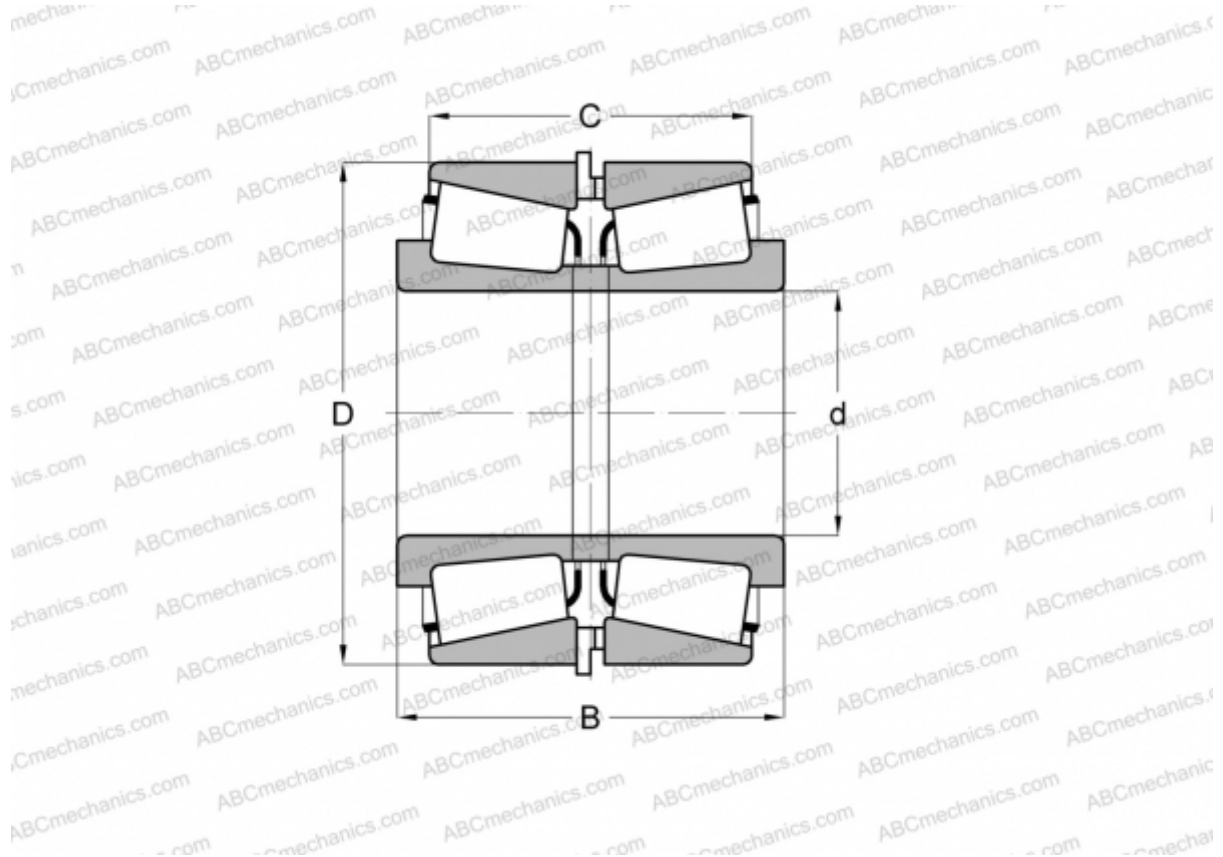

Technical specification

DIMENSIONS, MM

d	146,050
D	203,200
B	88,900
C	77,790

WEIGHT, KG 7,620

MANUFACTURER [TIMKEN](#)