

67790/67720 + X6S-67790/Y9S-67720

TIMKEN

Tapered roller bearings

TYPE: Roller bearings, Tapered, Tapered roller bearing assembly, Type 2TS-IM (X-mounting), two single row bearing with inner and outer distance rings

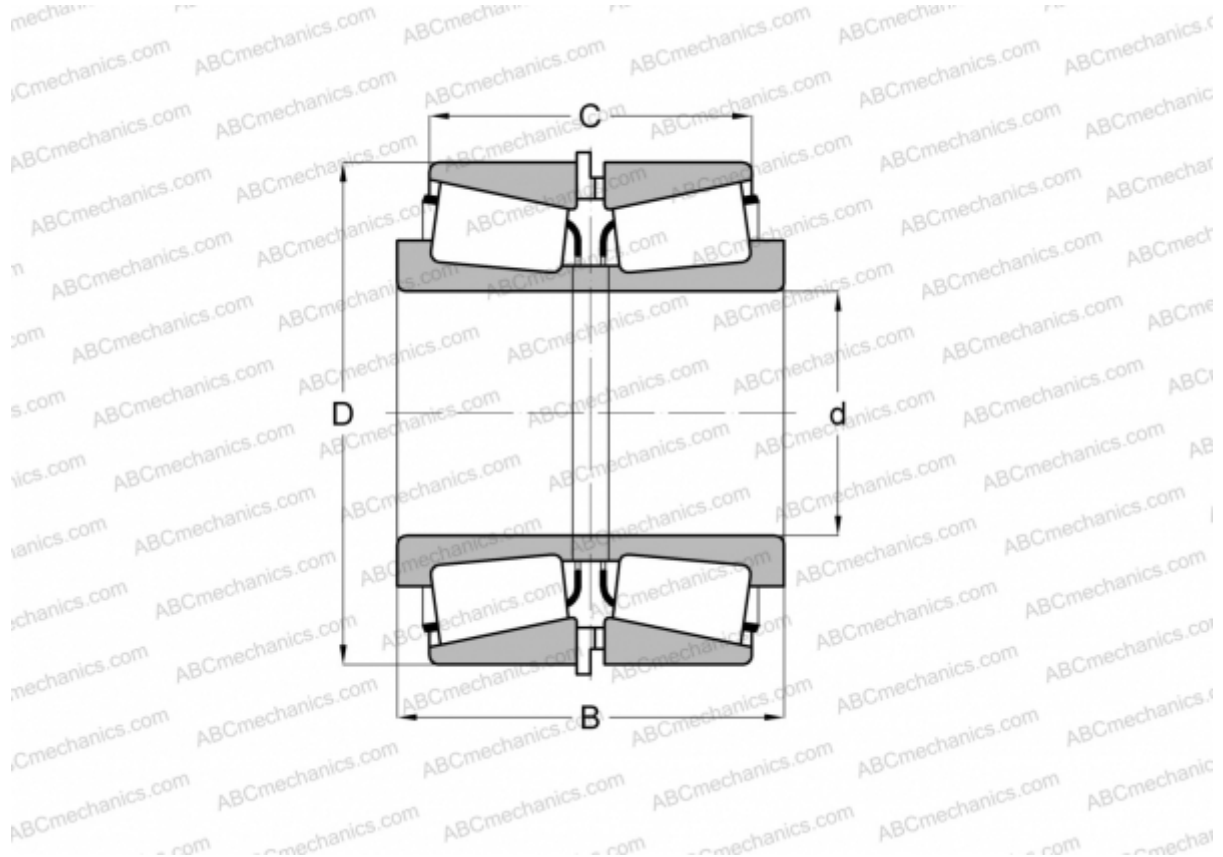

Technical specification

DIMENSIONS, MM

d	177,800
D	247,650
B	106,362
C	87,312

WEIGHT, KG 14,130

MANUFACTURER [TIMKEN](#)