

X32044XM/Y32044XM + K165766/K165765

TIMKEN

Tapered roller bearings

TYPE: Roller bearings, Tapered, Tapered roller bearing assembly, Type 2TS-IM (X-mounting), two single row bearing with inner and outer distance rings

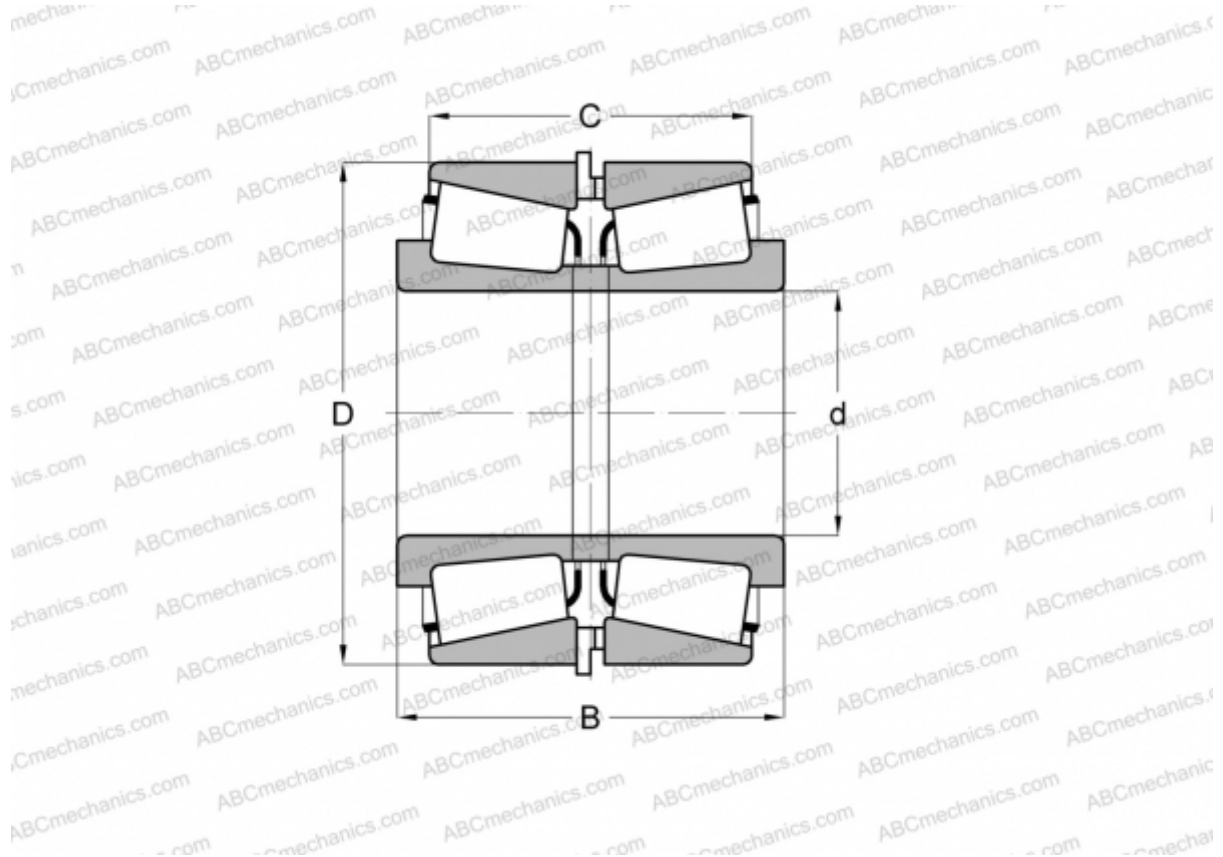

Technical specification

DIMENSIONS, MM

d	220,000
D	340,000
B	165,000
C	127,000

WEIGHT, KG 49,990

MANUFACTURER [TIMKEN](#)