

80480/80425 + X3S-80480 TIMKEN

Tapered roller bearings

TYPE: Roller bearings, Tapered, Tapered roller bearing assembly, Type 2TS-IM (X-mounting), two single row bearing with inner and outer distance rings

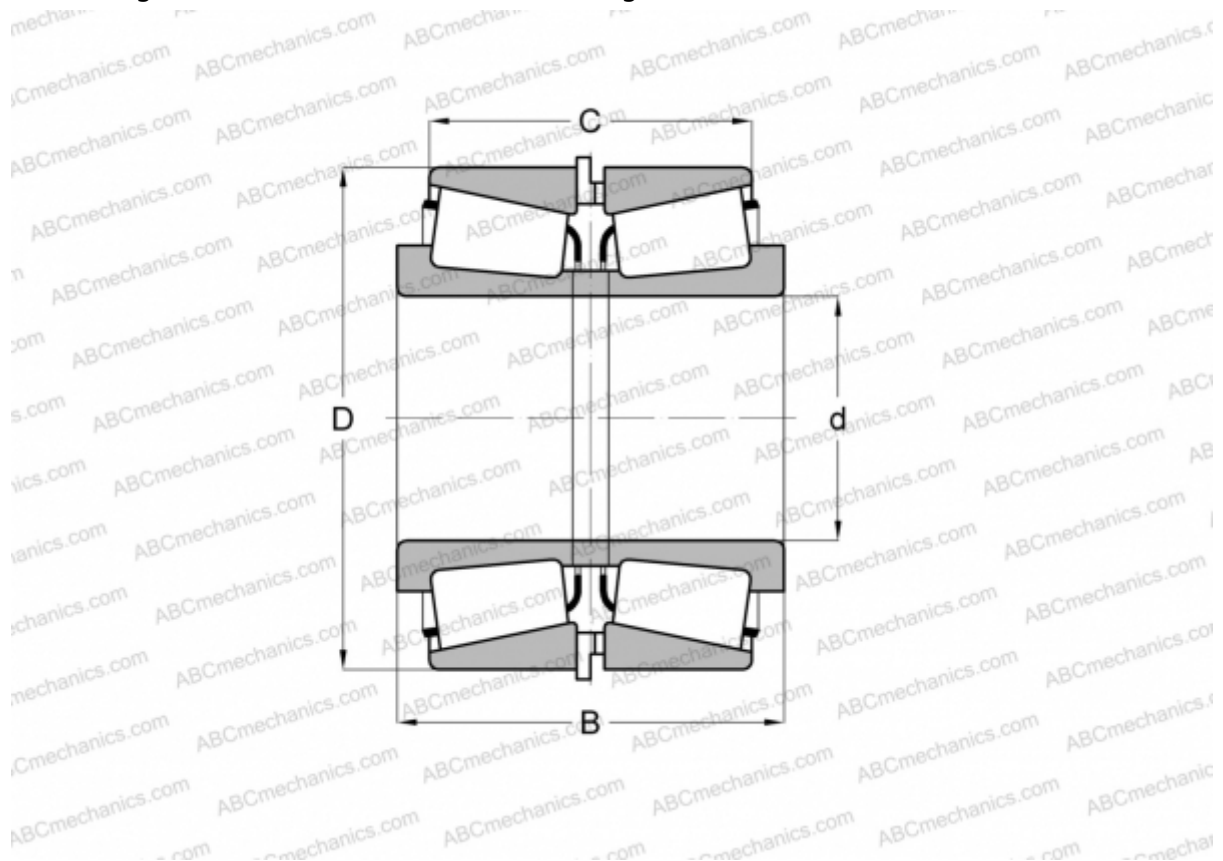

Technical specification

DIMENSIONS, MM

d	482,600
D	615,950
B	107,950
C	82,550

WEIGHT, KG 71,570

MANUFACTURER [TIMKEN](#)