

## LL778149/LL778110 + LL778149XA/LL778110EA TIMKEN

Tapered roller bearings

TYPE: Roller bearings, Tapered, Tapered roller bearing assembly, Type 2TS-IM (X-mounting), two single row bearing with inner and outer distance rings

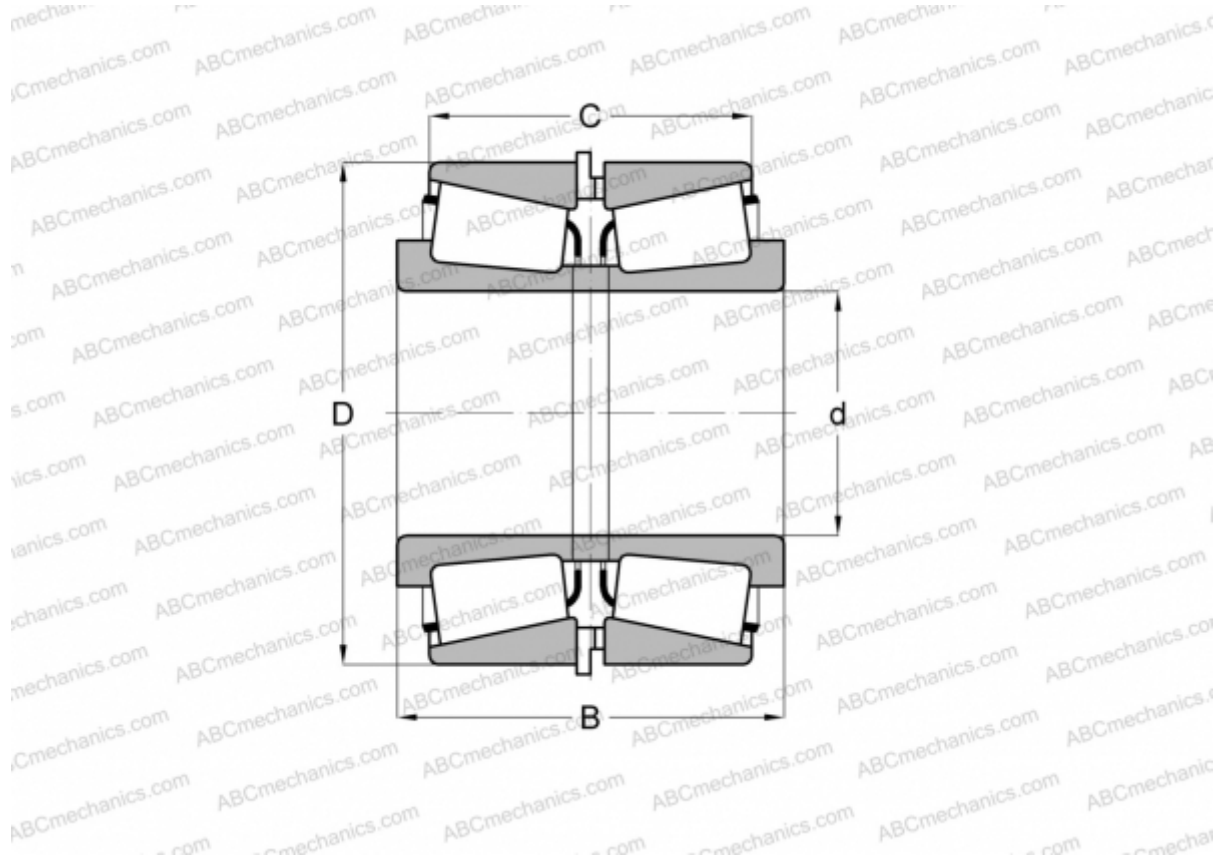

### Technical specification

#### DIMENSIONS, MM

d	584,200
D	685,800
B	107,950
C	79,375

**WEIGHT, KG** 60,960

**MANUFACTURER** [TIMKEN](#)