

26885/26820 + Y1S-26820 TIMKEN

Tapered roller bearings

TYPE: Roller bearings, Tapered, Tapered roller bearing assembly, Type 2TS-DM (O-mounting), two single row bearing, mounting inner ring, outer distance ring

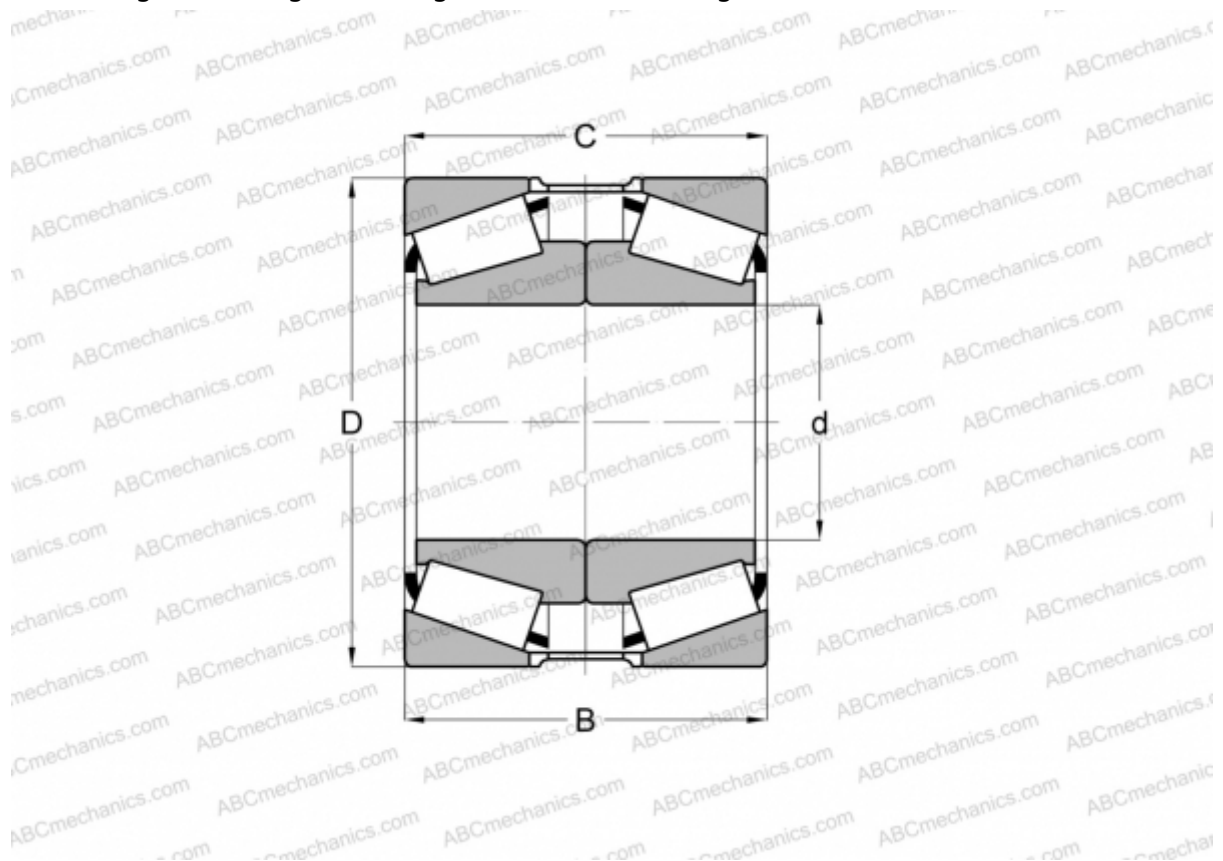

Technical specification

DIMENSIONS, MM

d	41,275
D	80,167
B	50,800
T	50,800

WEIGHT, KG 1,150

MANUFACTURER [TIMKEN](#)