

25580/25520 + Y4S-25520 TIMKEN

Tapered roller bearings

TYPE: Roller bearings, Tapered, Tapered roller bearing assembly, Type 2TS-DM (O-mounting), two single row bearing, mounting inner ring, outer distance ring

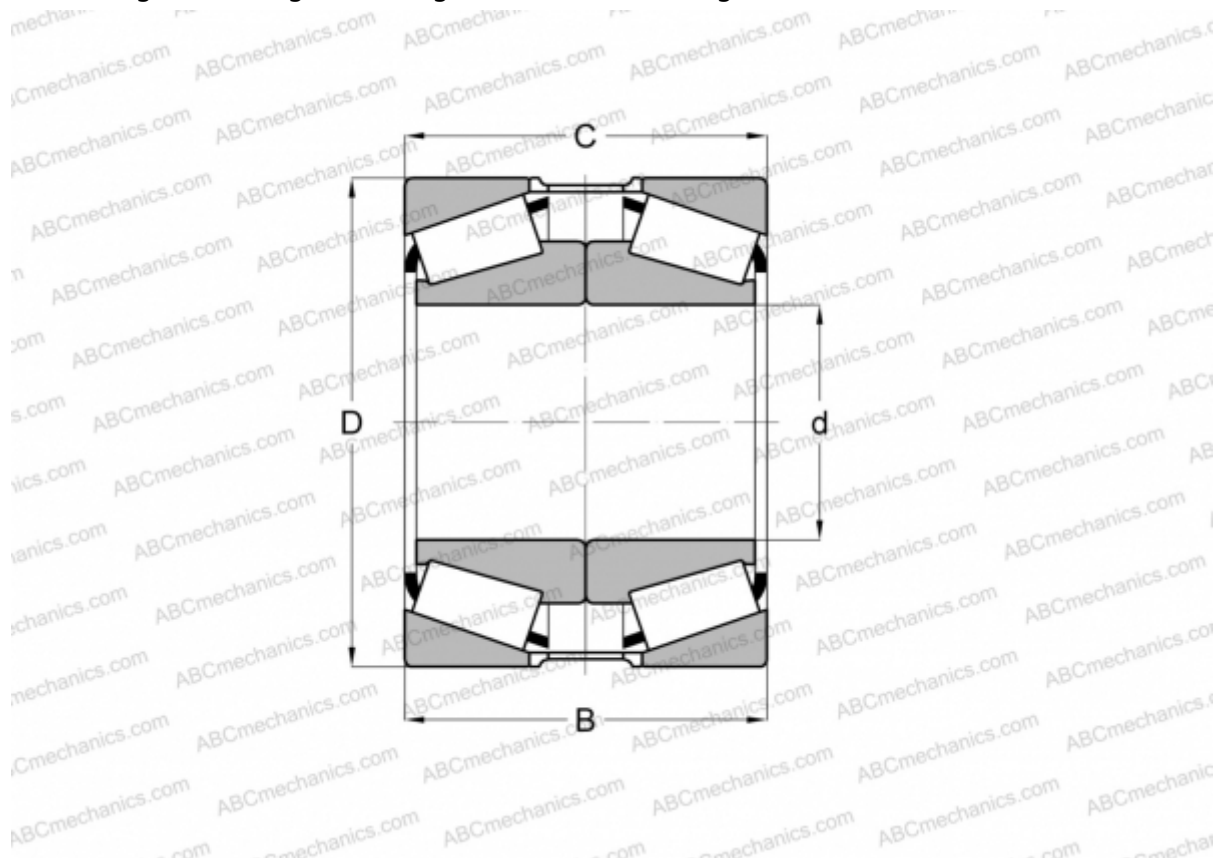

Technical specification

DIMENSIONS, MM

d	44,450
D	82,931
B	50,800
T	47,625

WEIGHT, KG 1,180

MANUFACTURER [TIMKEN](#)