

28680/28622 + Y4S-28622 TIMKEN

Tapered roller bearings

TYPE: Roller bearings, Tapered, Tapered roller bearing assembly, Type 2TS-DM (O-mounting), two single row bearing, mounting inner ring, outer distance ring

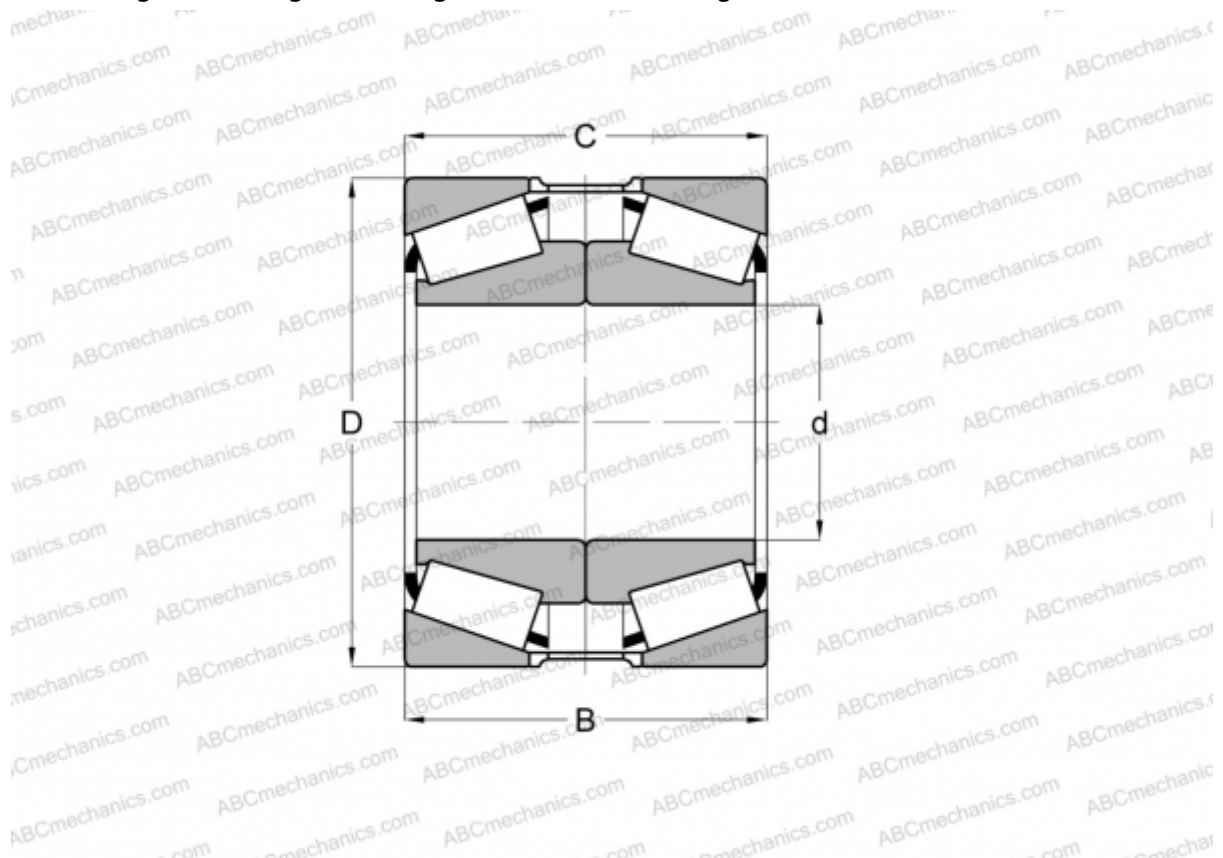

Technical specification

DIMENSIONS, MM

d	55,562
D	97,630
B	49,216
T	49,215

WEIGHT, KG 1,570

MANUFACTURER [TIMKEN](#)