

6379/6320 + Y3S-6320 TIMKEN

Tapered roller bearings

TYPE: Roller bearings, Tapered, Tapered roller bearing assembly, Type 2TS-DM (O-mounting), two single row bearing, mounting inner ring, outer distance ring

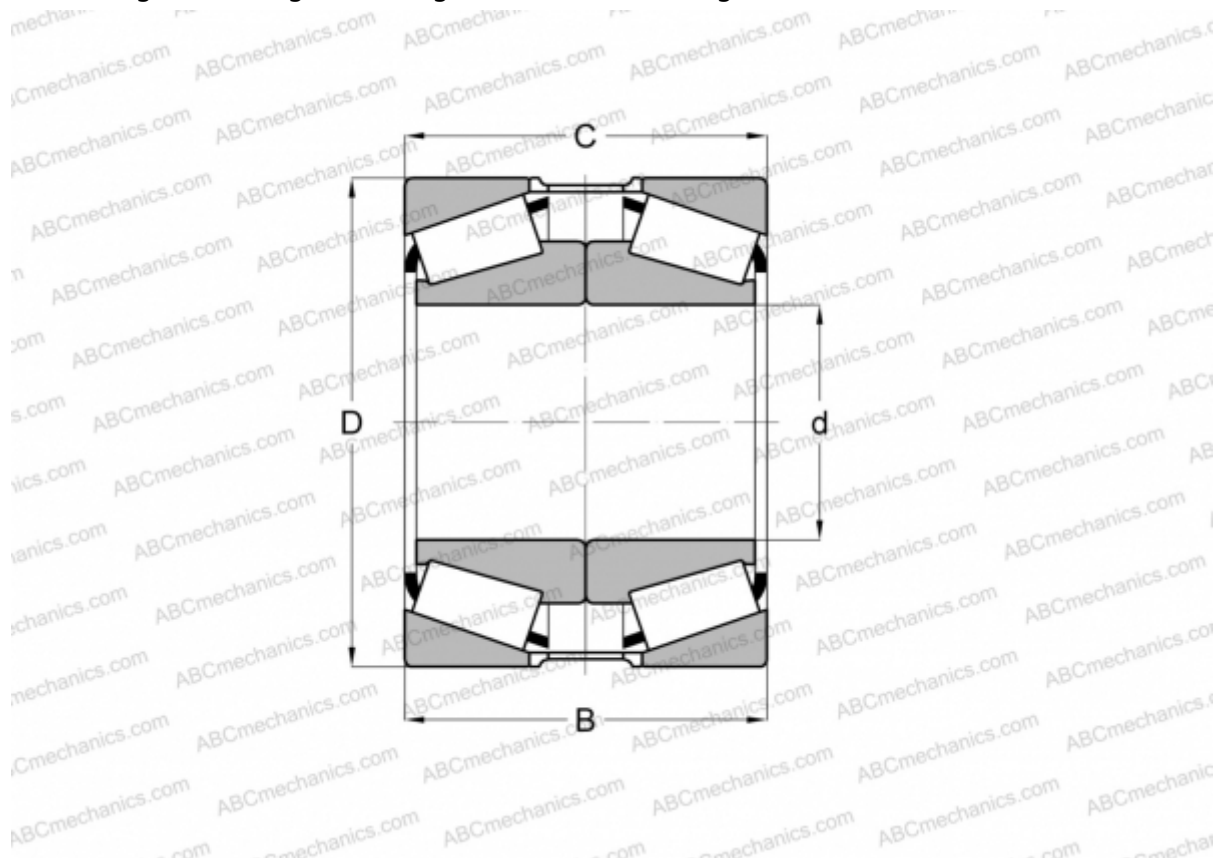

Technical specification

DIMENSIONS, MM

d	65,087
D	135,755
B	112,014
T	107,950

WEIGHT, KG 7,500

MANUFACTURER [TIMKEN](#)