

47487/47420 + Y1S-47420 TIMKEN

Tapered roller bearings

TYPE: Roller bearings, Tapered, Tapered roller bearing assembly, Type 2TS-DM (O-mounting), two single row bearing, mounting inner ring, outer distance ring

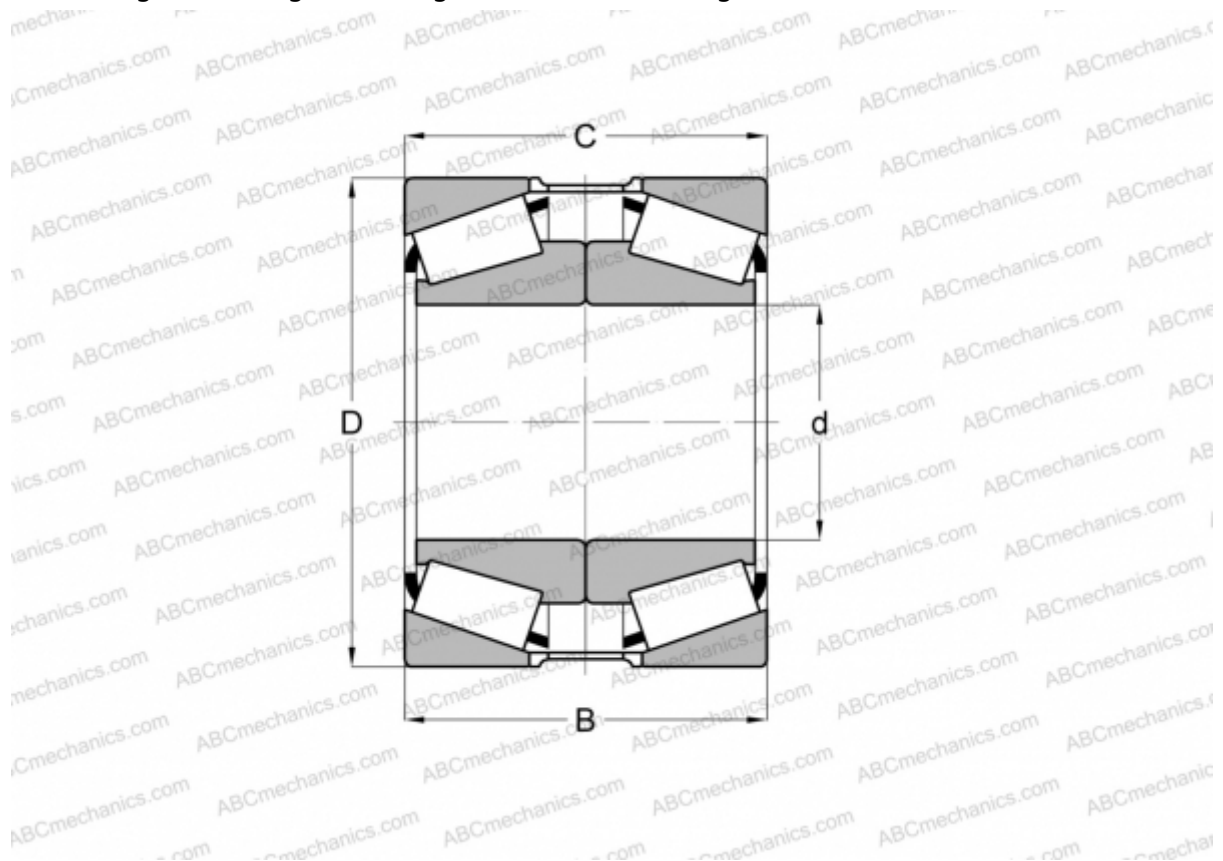

Technical specification

DIMENSIONS, MM

d	69,850
D	120,000
B	65,090
T	65,090

WEIGHT, KG 3,030

MANUFACTURER [TIMKEN](#)