

9285/9220 + Y1S-9220 TIMKEN

Tapered roller bearings

TYPE: Roller bearings, Tapered, Tapered roller bearing assembly, Type 2TS-DM (O-mounting), two single row bearing, mounting inner ring, outer distance ring

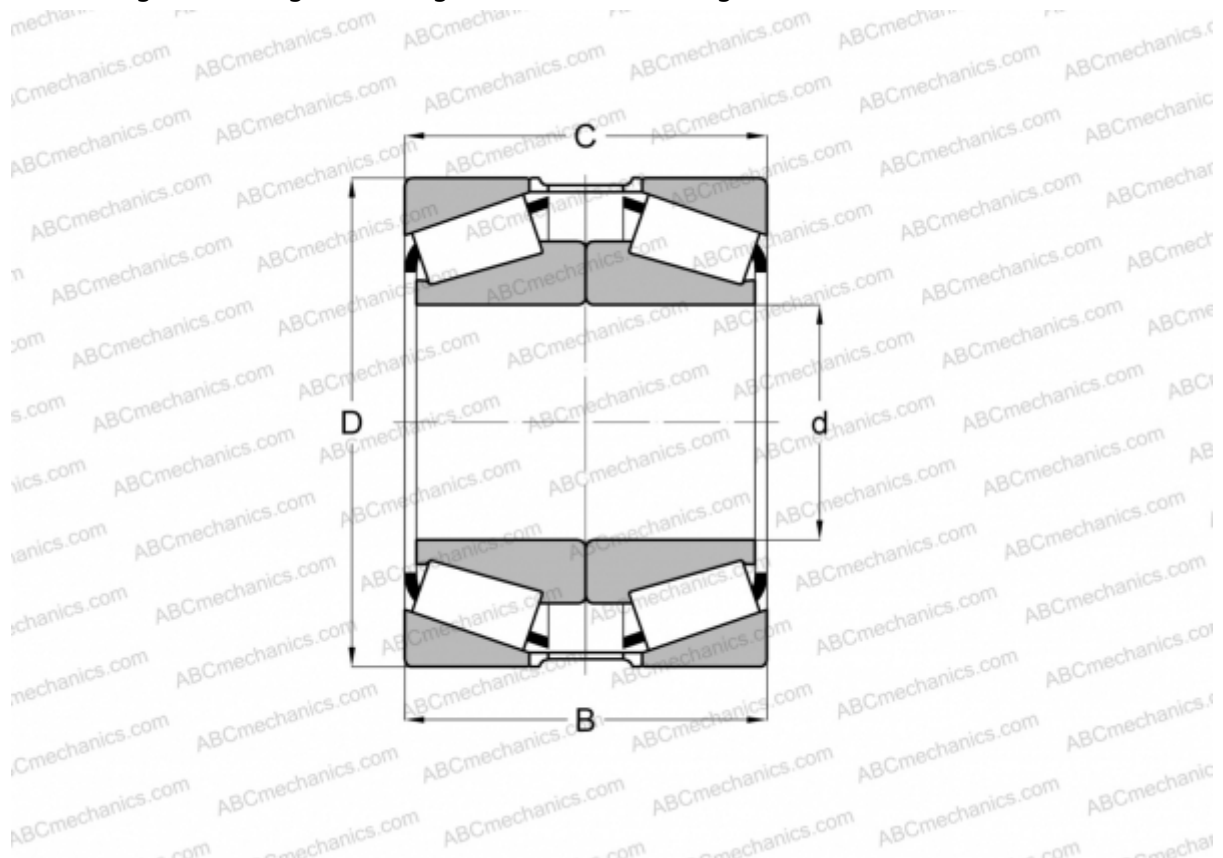

Technical specification

DIMENSIONS, MM

d	76,200
D	161,925
B	92,076
T	98,425

WEIGHT, KG 8,680

MANUFACTURER [TIMKEN](#)