

496/493 + Y4S-493 TIMKEN

Tapered roller bearings

TYPE: Roller bearings, Tapered, Tapered roller bearing assembly, Type 2TS-DM (O-mounting), two single row bearing, mounting inner ring, outer distance ring

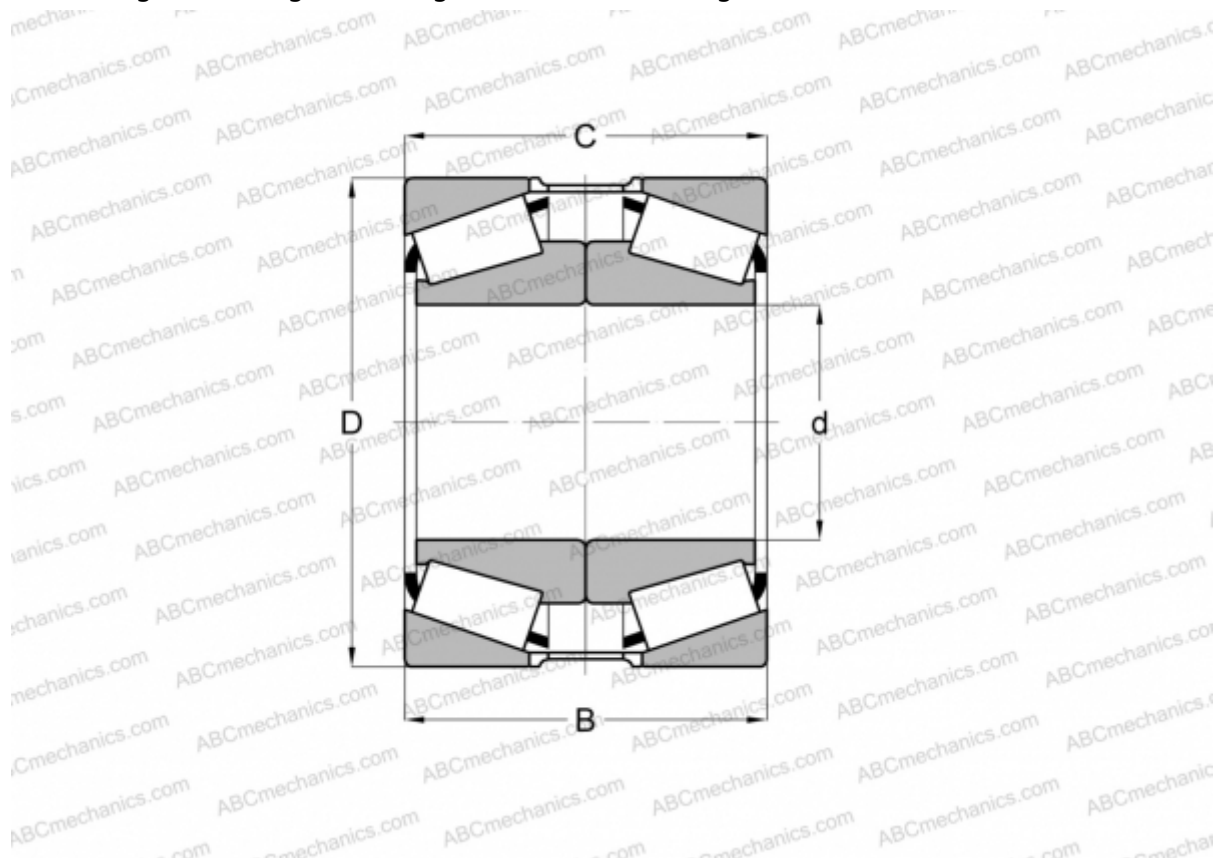

Technical specification

DIMENSIONS, MM

d	80,962
D	136,525
B	59,538
T	60,325

WEIGHT, KG 3,500

MANUFACTURER [TIMKEN](#)