

42381/42584 + Y3S-42584 TIMKEN

Tapered roller bearings

TYPE: Roller bearings, Tapered, Tapered roller bearing assembly, Type 2TS-DM (O-mounting), two single row bearing, mounting inner ring, outer distance ring

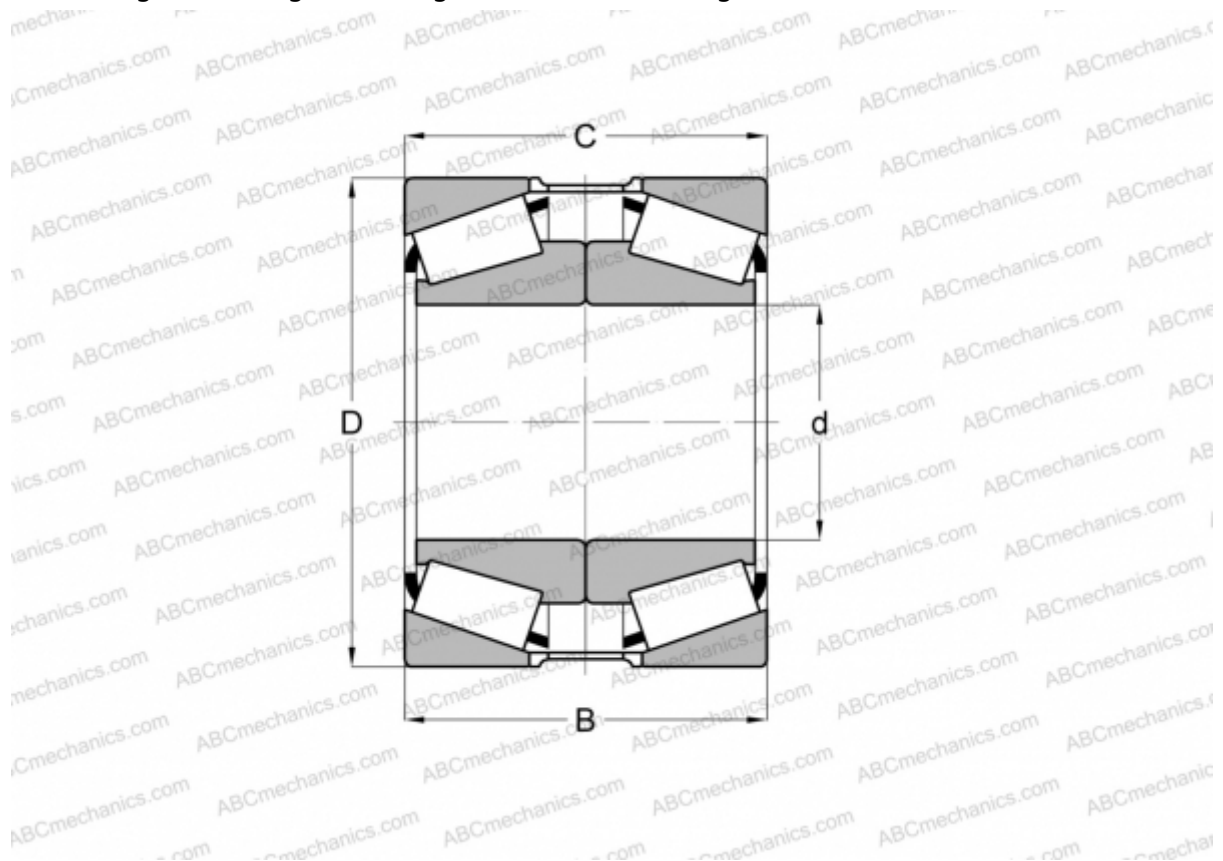

Technical specification

DIMENSIONS, MM

d	96,838
D	148,430
B	57,942
T	57,150

WEIGHT, KG 3,530

MANUFACTURER [TIMKEN](#)