

90381/90744 + Y2S-90744 TIMKEN

Tapered roller bearings

TYPE: Roller bearings, Tapered, Tapered roller bearing assembly, Type 2TS-DM (O-mounting), two single row bearing, mounting inner ring, outer distance ring

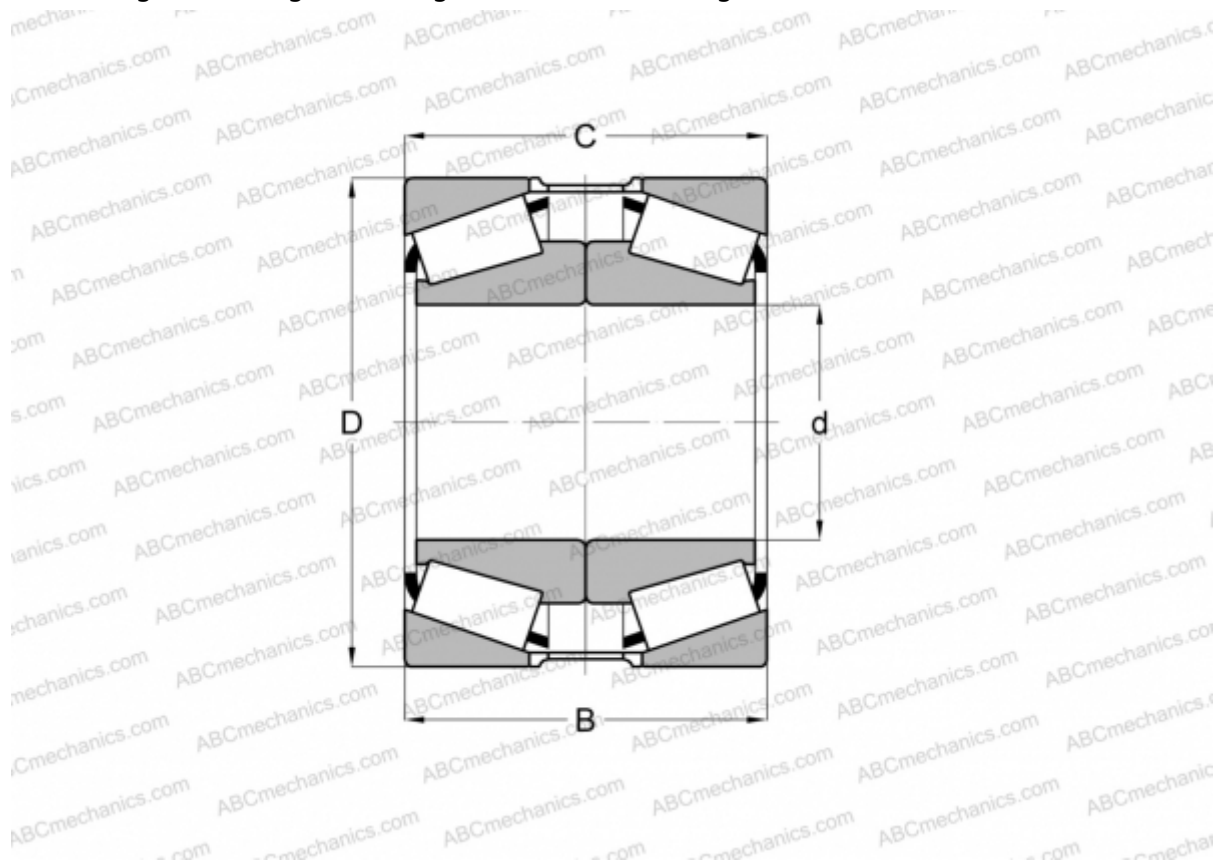

Technical specification

DIMENSIONS, MM

d	96,838
D	188,912
B	92,076
T	101,600

WEIGHT, KG 11,770

MANUFACTURER [TIMKEN](#)