

95475/95925 + Y1S-95925 TIMKEN

Tapered roller bearings

TYPE: Roller bearings, Tapered, Tapered roller bearing assembly, Type 2TS-DM (O-mounting), two single row bearing, mounting inner ring, outer distance ring

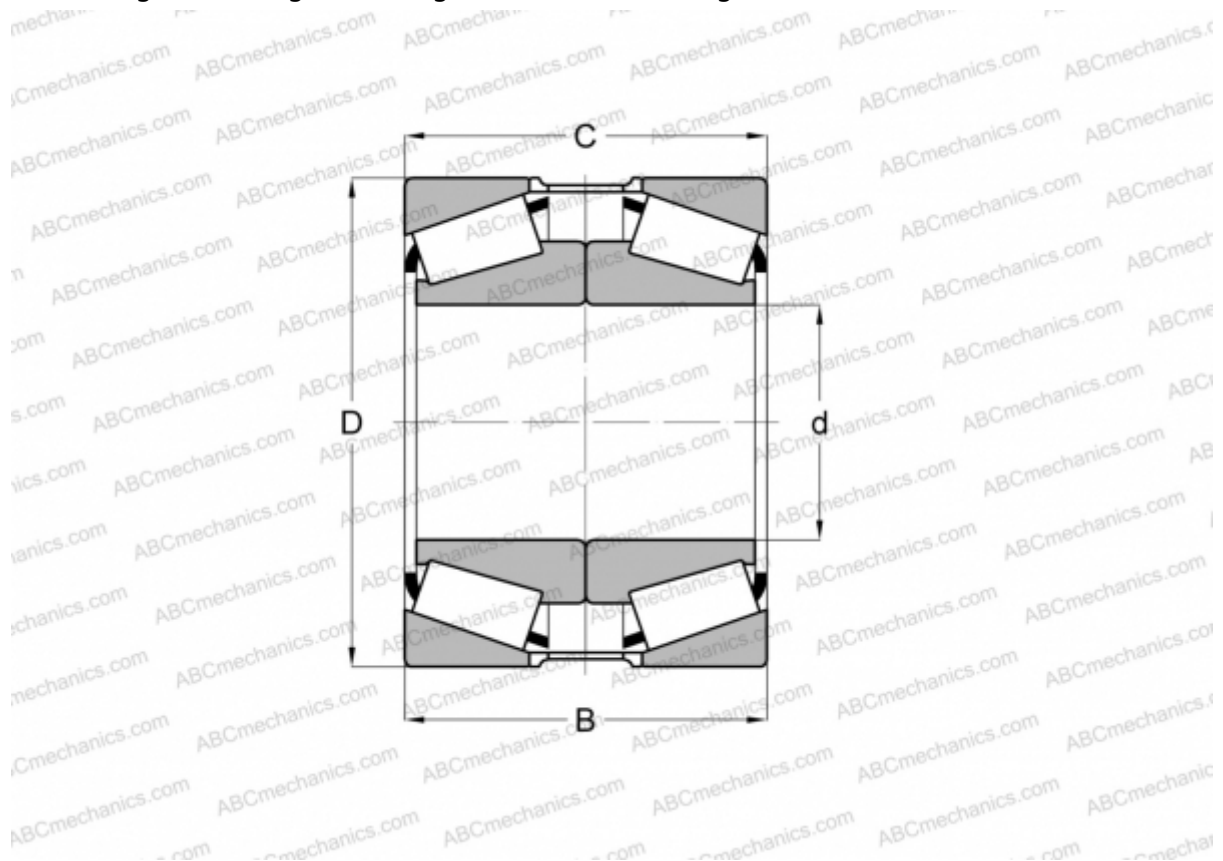

Technical specification

DIMENSIONS, MM

d	120,650
D	234,950
B	127,000
T	127,000

WEIGHT, KG 25,890

MANUFACTURER [TIMKEN](#)