

86669/86100 + Y2S-86100 TIMKEN

Tapered roller bearings

TYPE: Roller bearings, Tapered, Tapered roller bearing assembly, Type 2TS-DM (O-mounting), two single row bearing, mounting inner ring, outer distance ring

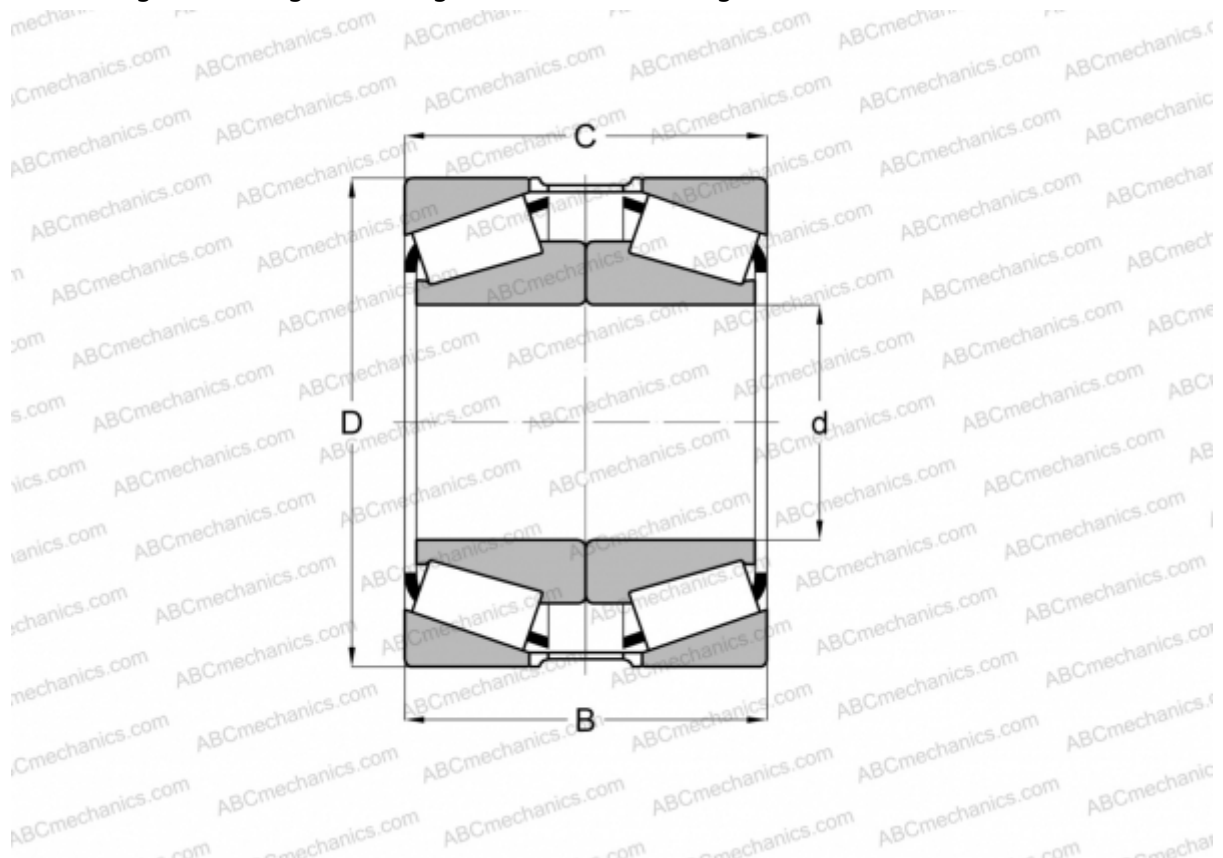

Technical specification

DIMENSIONS, MM

d	170,000
D	254,000
B	92,076
T	92,075

WEIGHT, KG 15,100

MANUFACTURER [TIMKEN](#)