

67790/67720 + Y3S-67720 TIMKEN

Tapered roller bearings

TYPE: Roller bearings, Tapered, Tapered roller bearing assembly, Type 2TS-DM (O-mounting), two single row bearing, mounting inner ring, outer distance ring

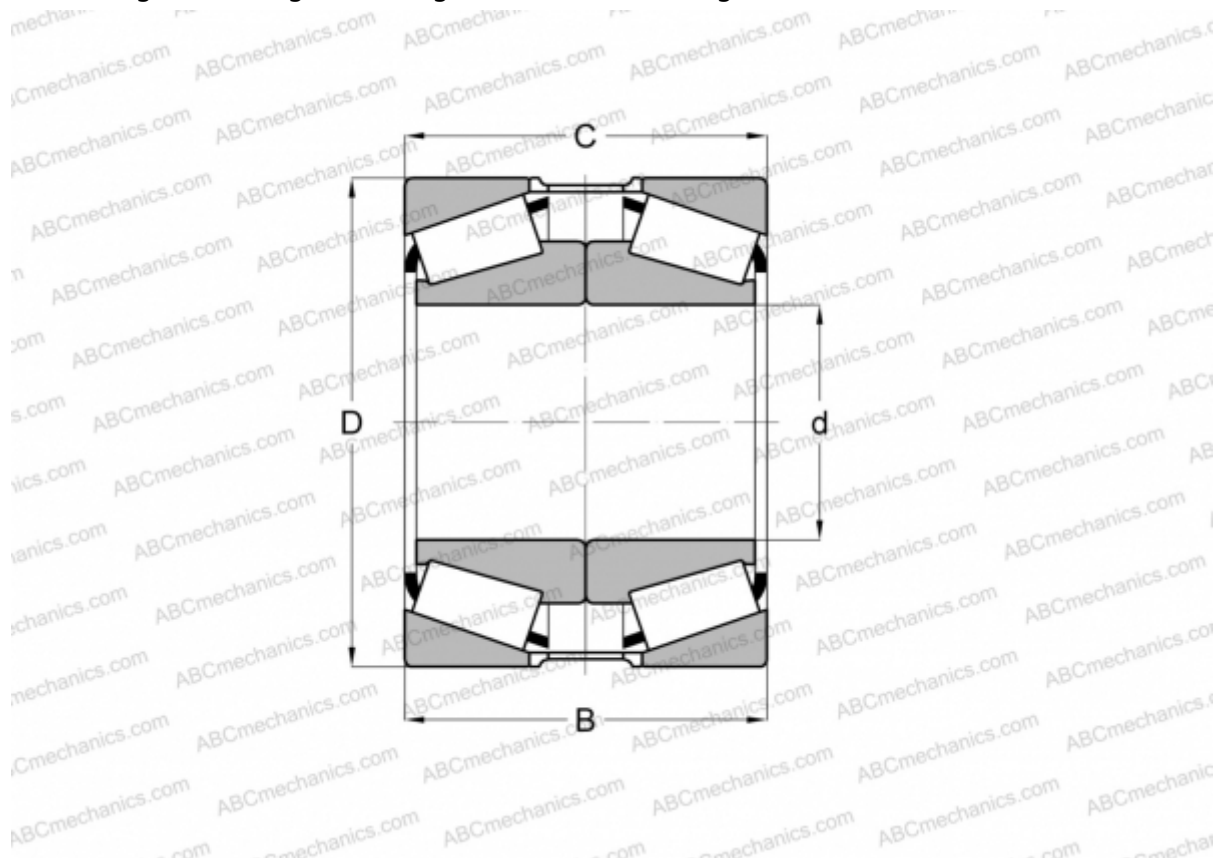

Technical specification

DIMENSIONS, MM

d	177,800
D	247,650
B	95,250
T	95,250

WEIGHT, KG 13,790

MANUFACTURER [TIMKEN](#)