

EE350750/351687 + Y1S-351687 TIMKEN

Tapered roller bearings

TYPE: Roller bearings, Tapered, Tapered roller bearing assembly, Type 2TS-DM (O-mounting), two single row bearing, mounting inner ring, outer distance ring

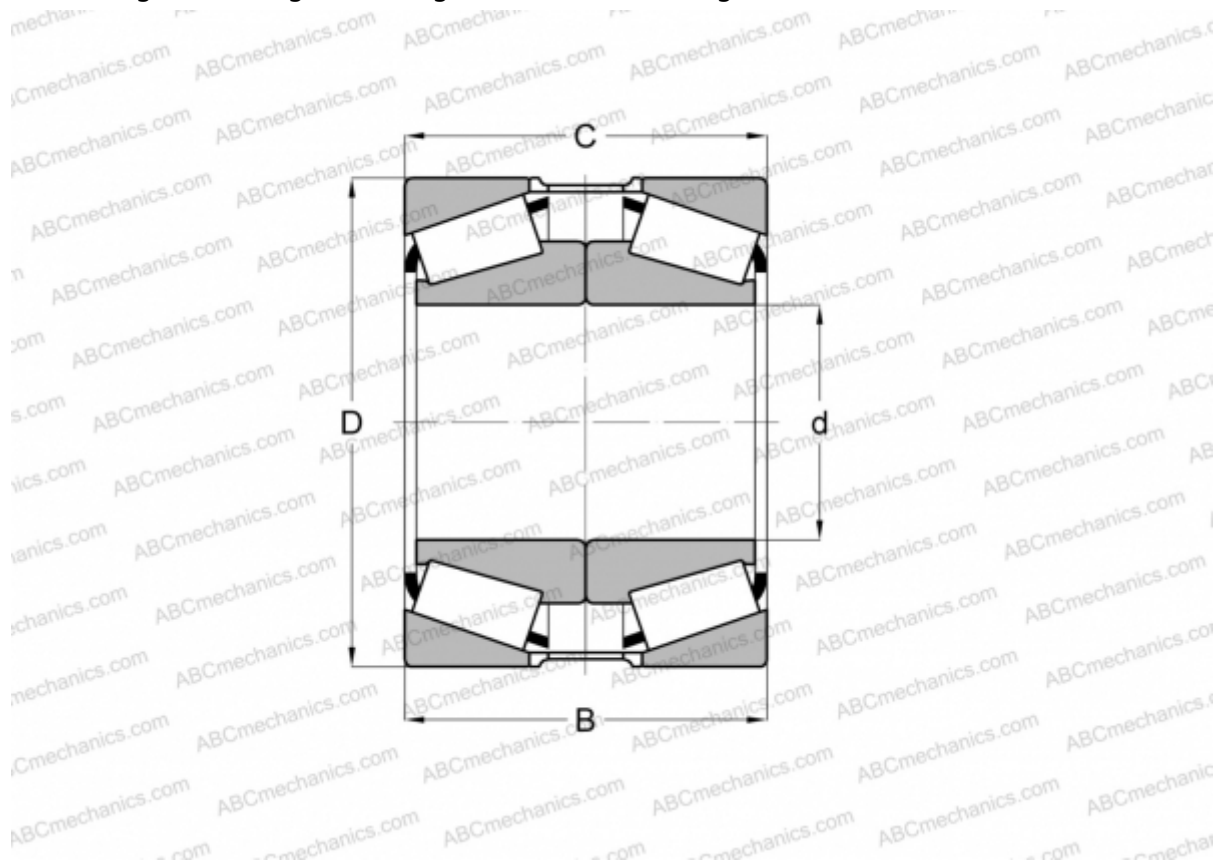

Technical specification

DIMENSIONS, MM

d	190,500
D	428,625
B	190,500
T	212,725

WEIGHT, KG 139,800

MANUFACTURER [TIMKEN](#)