

EE420801/421437 + Y2S-421437 TIMKEN

Tapered roller bearings

TYPE: Roller bearings, Tapered, Tapered roller bearing assembly, Type 2TS-DM (O-mounting), two single row bearing, mounting inner ring, outer distance ring

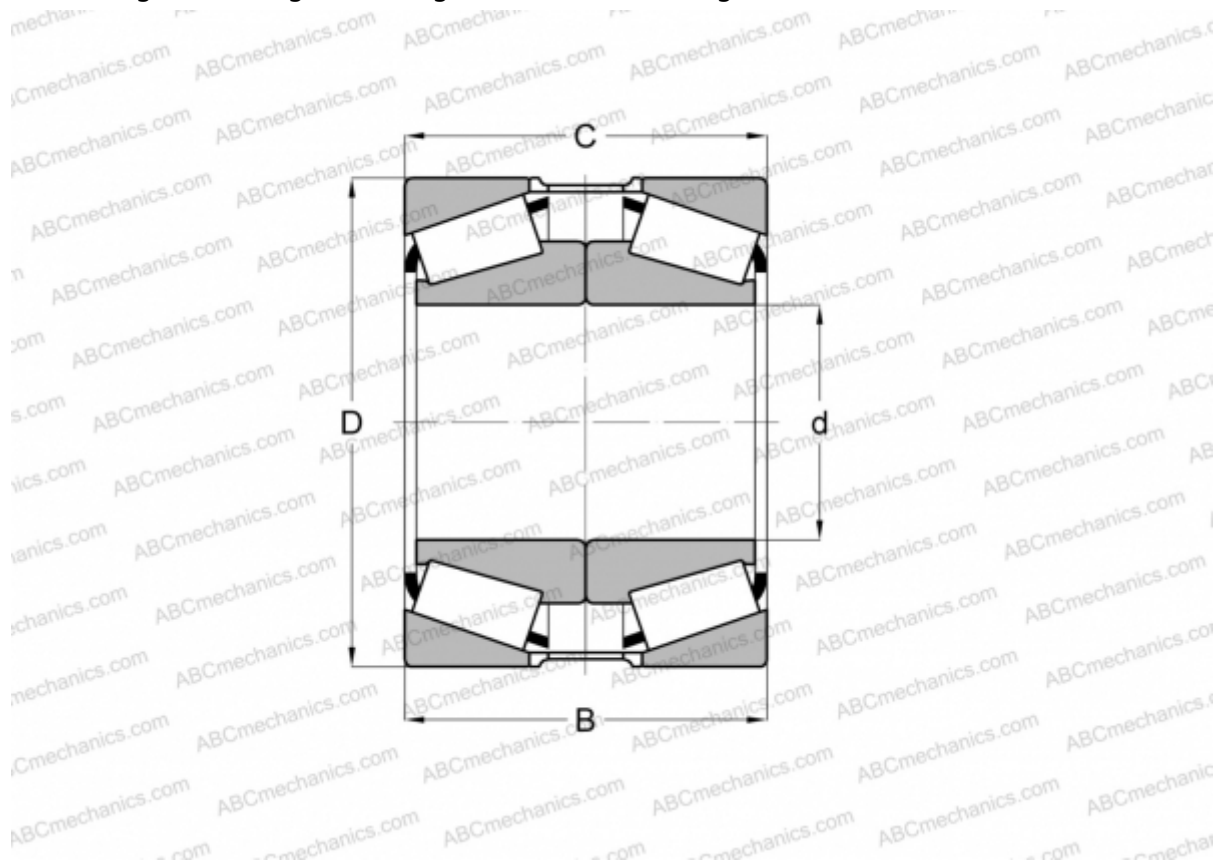

Technical specification

DIMENSIONS, MM

d	203,200
D	365,049
B	177,794
T	184,150

WEIGHT, KG 78,680

MANUFACTURER [TIMKEN](#)