

## NP852610/NP588721 + K167429 TIMKEN

Tapered roller bearings

TYPE: Roller bearings, Tapered, Tapered roller bearing assembly, Type 2TS-DM (O-mounting), two single row bearing, mounting inner ring, outer distance ring

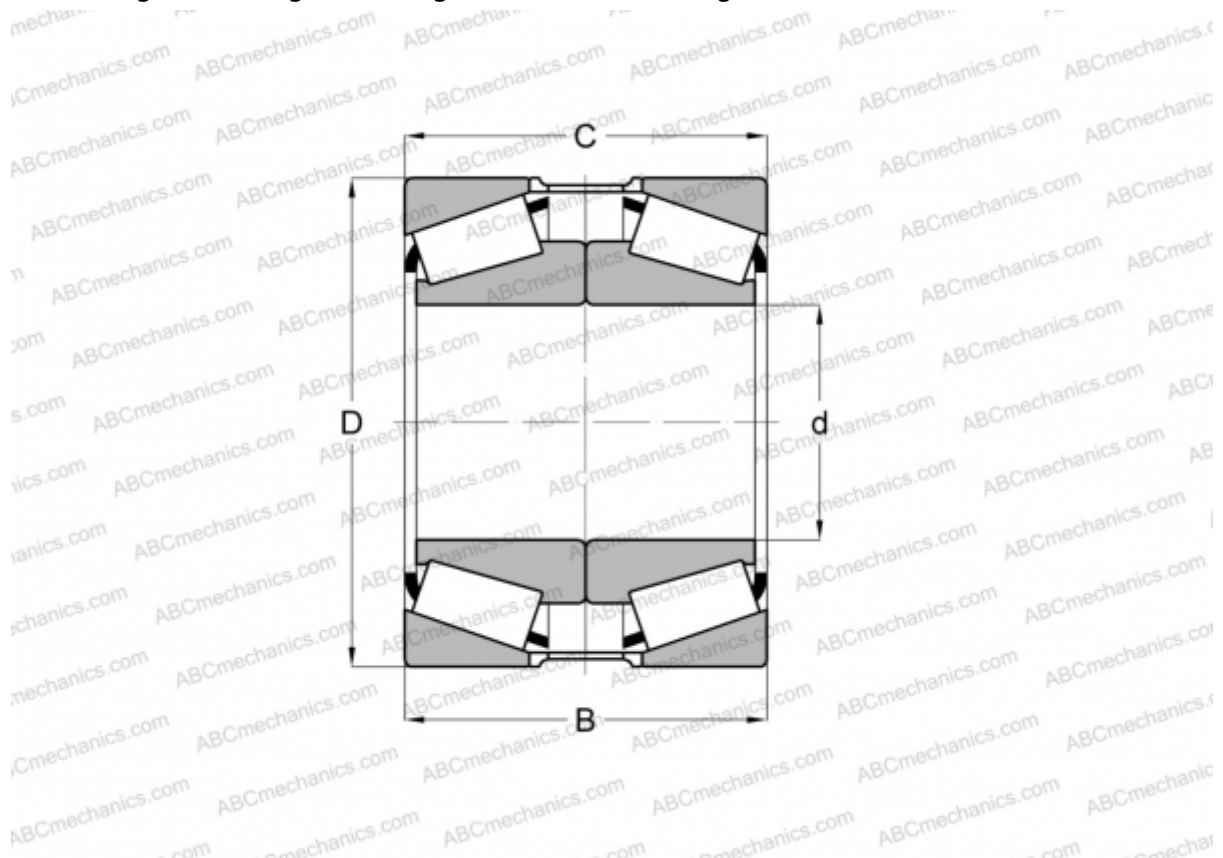

### Technical specification

#### DIMENSIONS, MM

d	400,000
D	510,000
B	124,000
T	124,000

**WEIGHT, KG** 62,340

**MANUFACTURER** [TIMKEN](#)