

NP837820/NP562053 + K163378 TIMKEN

Tapered roller bearings

TYPE: Roller bearings, Tapered, Tapered roller bearing assembly, Type 2TS-DM (O-mounting), two single row bearing, mounting inner ring, outer distance ring

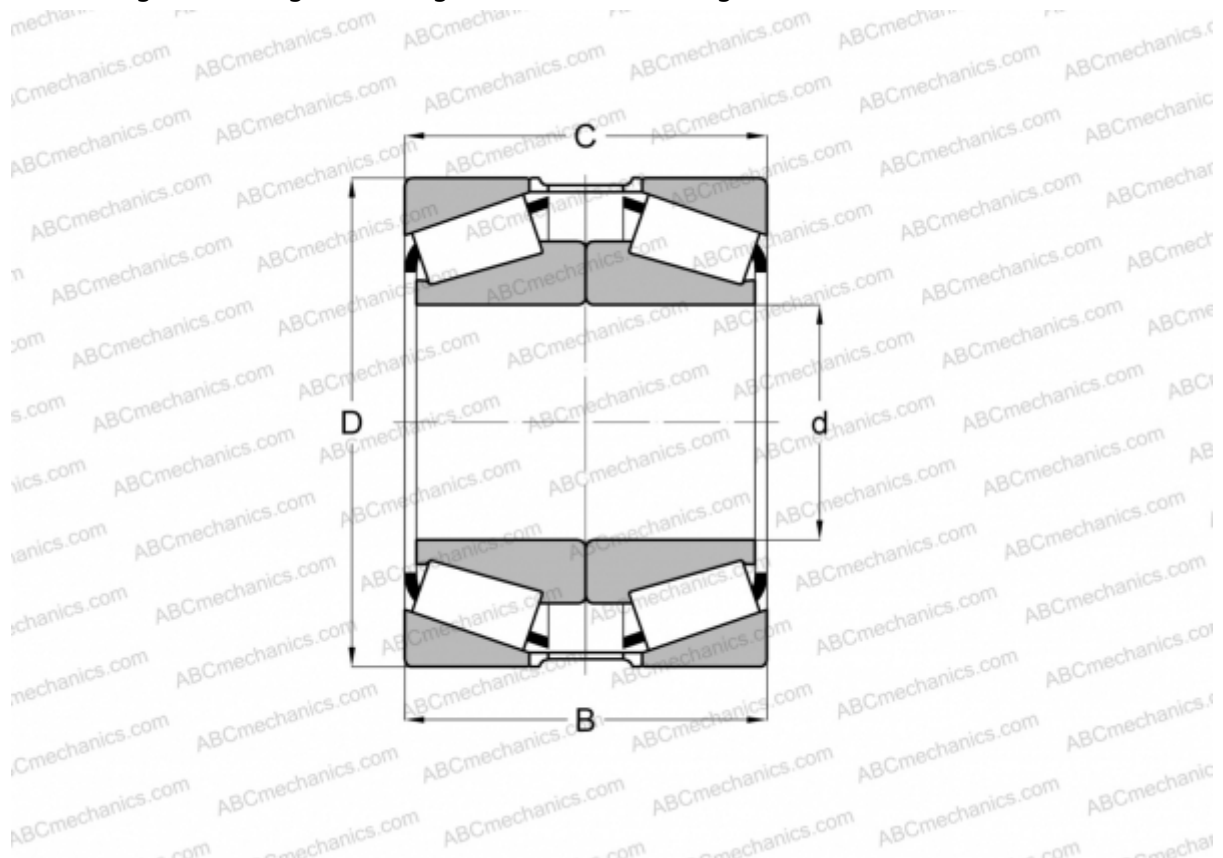

Technical specification

DIMENSIONS, MM

d	460,000
D	860,000
B	380,000
T	420,000

WEIGHT, KG 1087,000

MANUFACTURER [TIMKEN](#)