

74025/74052P GAMET

Tapered roller bearings

TYPE: Roller bearings, Tapered, Precision, GAMET type P, constant preload

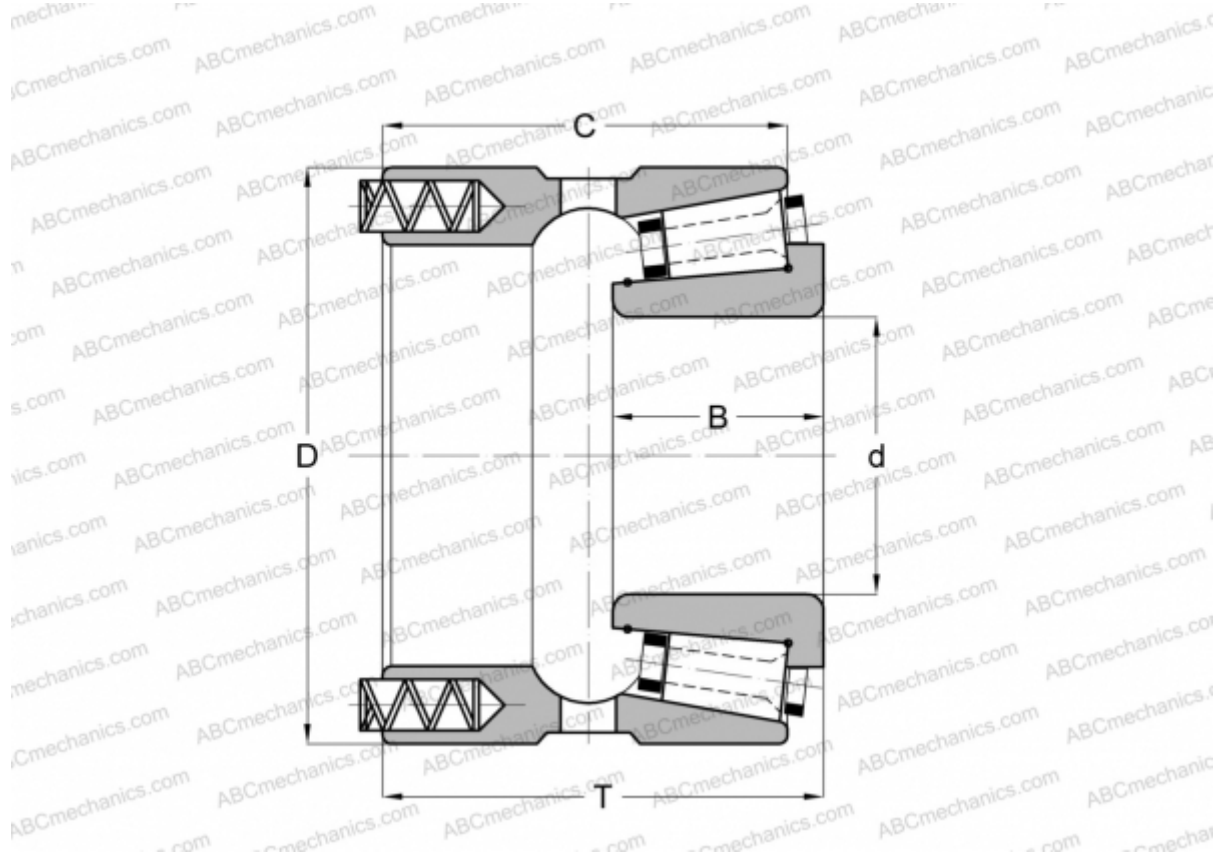

Technical specification

DIMENSIONS, MM

d	25,000
D	52,000
B	19,000
T	39,750
C	36,500

WEIGHT, KG 0,340

MANUFACTURER [GAMET](#)