

100034X/100080P GAMET

Tapered roller bearings

TYPE: Roller bearings, Tapered, Precision, GAMET type P, constant preload

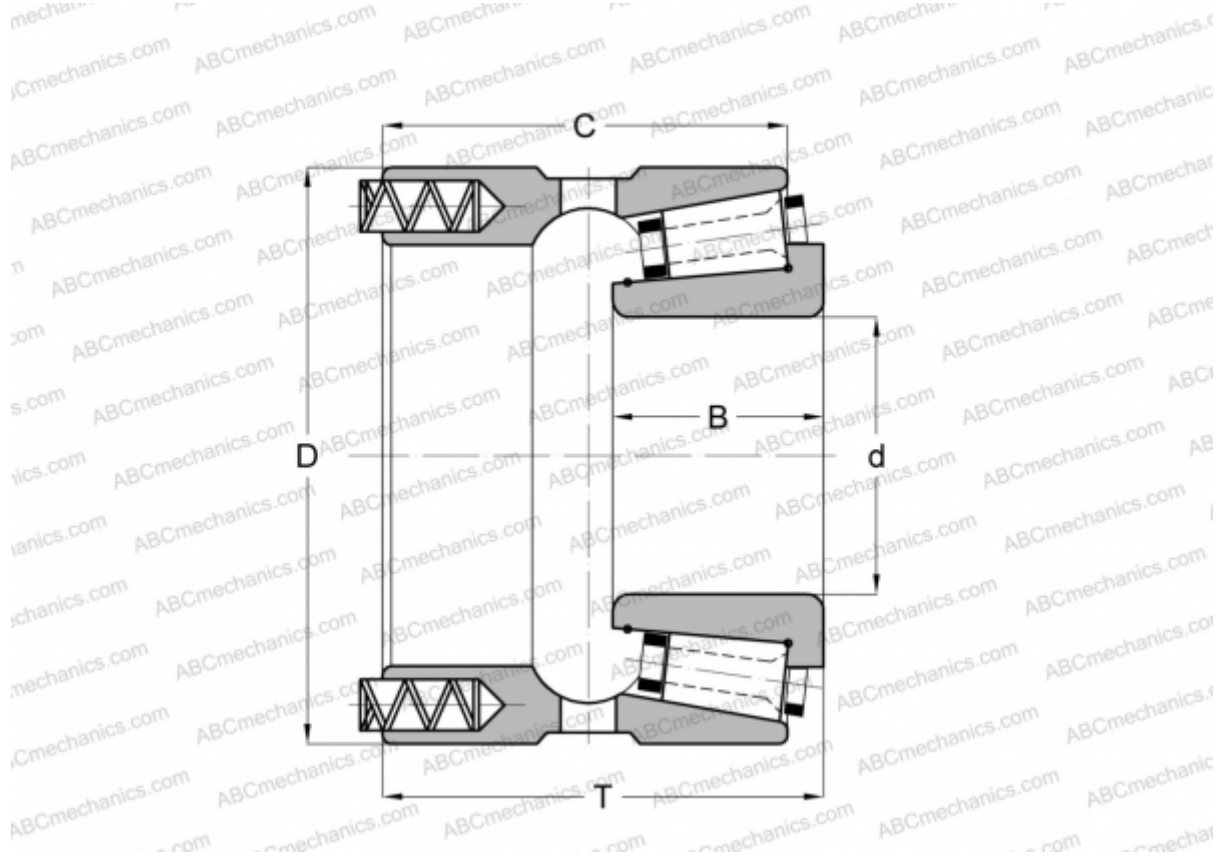

Technical specification

DIMENSIONS, MM

d	34,925
D	80,000
B	26,000
T	51,750
C	46,500

WEIGHT, KG 0,750

MANUFACTURER [GAMET](#)