

131090/131150P GAMET

Tapered roller bearings

TYPE: Roller bearings, Tapered, Precision, GAMET type P, constant preload

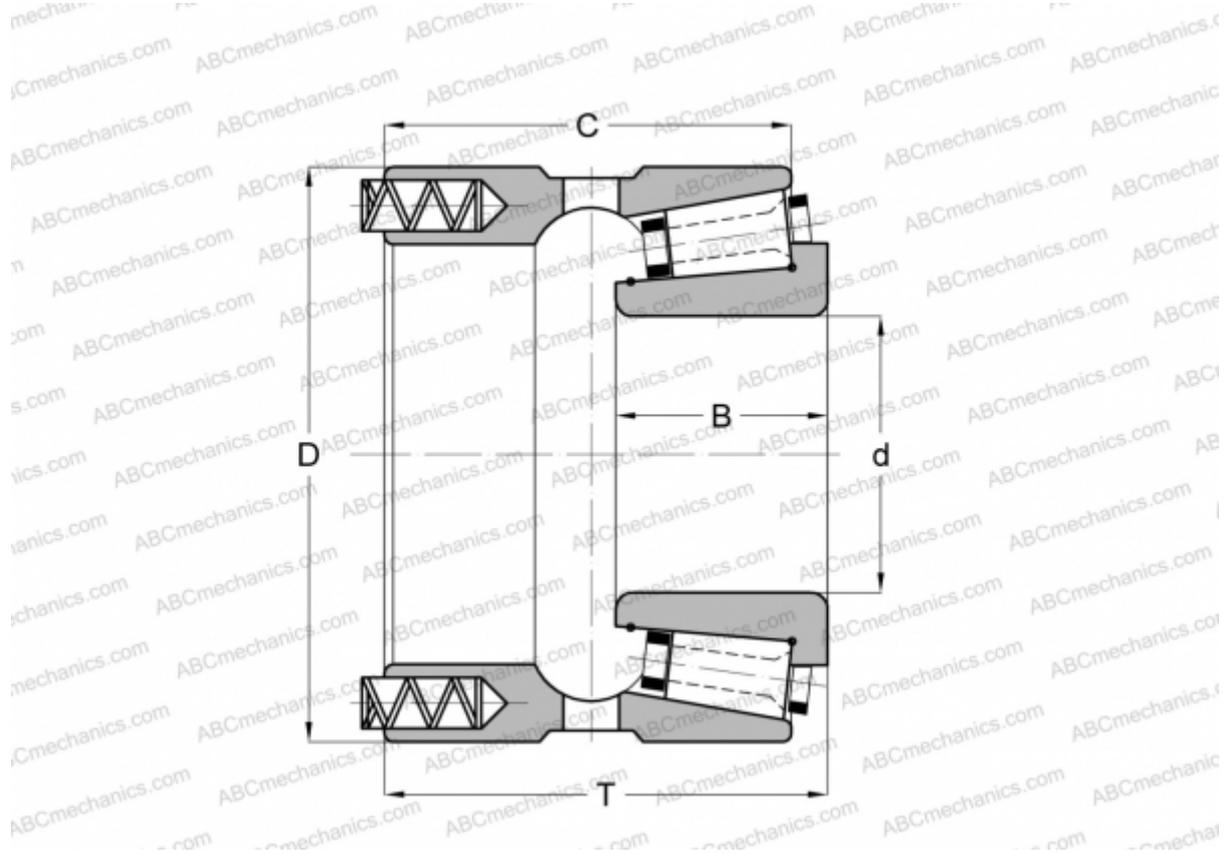

Technical specification

DIMENSIONS, MM

d	90,000
D	150,000
B	33,750
T	68,500
C	62,000

WEIGHT, KG 3,800

MANUFACTURER [GAMET](#)