

203156/203235P GAMET

Tapered roller bearings

TYPE: Roller bearings, Tapered, Precision, GAMET type P, constant preload

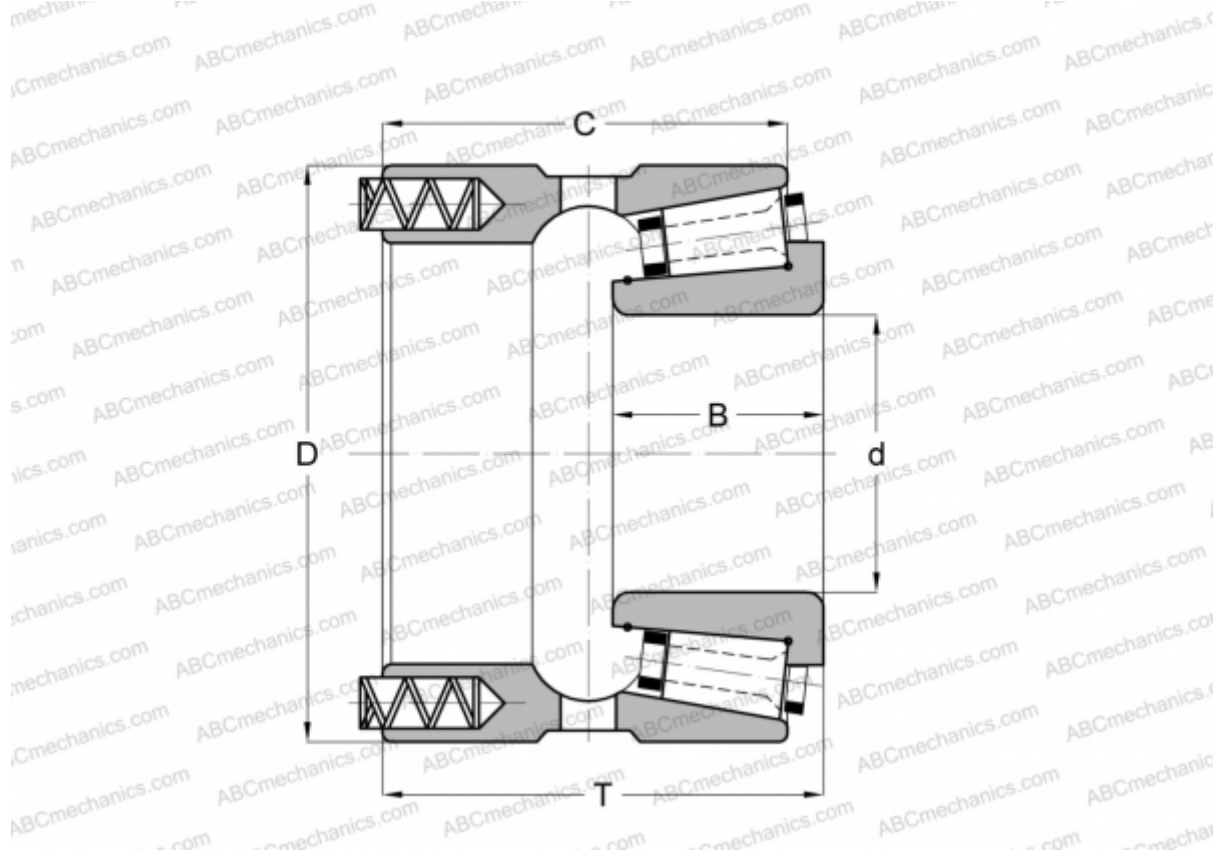

Technical specification

DIMENSIONS, MM

d	156,000
D	235,000
B	51,000
T	101,000
C	92,000

WEIGHT, KG 11,830

MANUFACTURER [GAMET](#)