

## 80033X/80068G GAMET

Tapered roller bearings

TYPE: Roller bearings, Tapered, Precision, GAMET type G, double-row

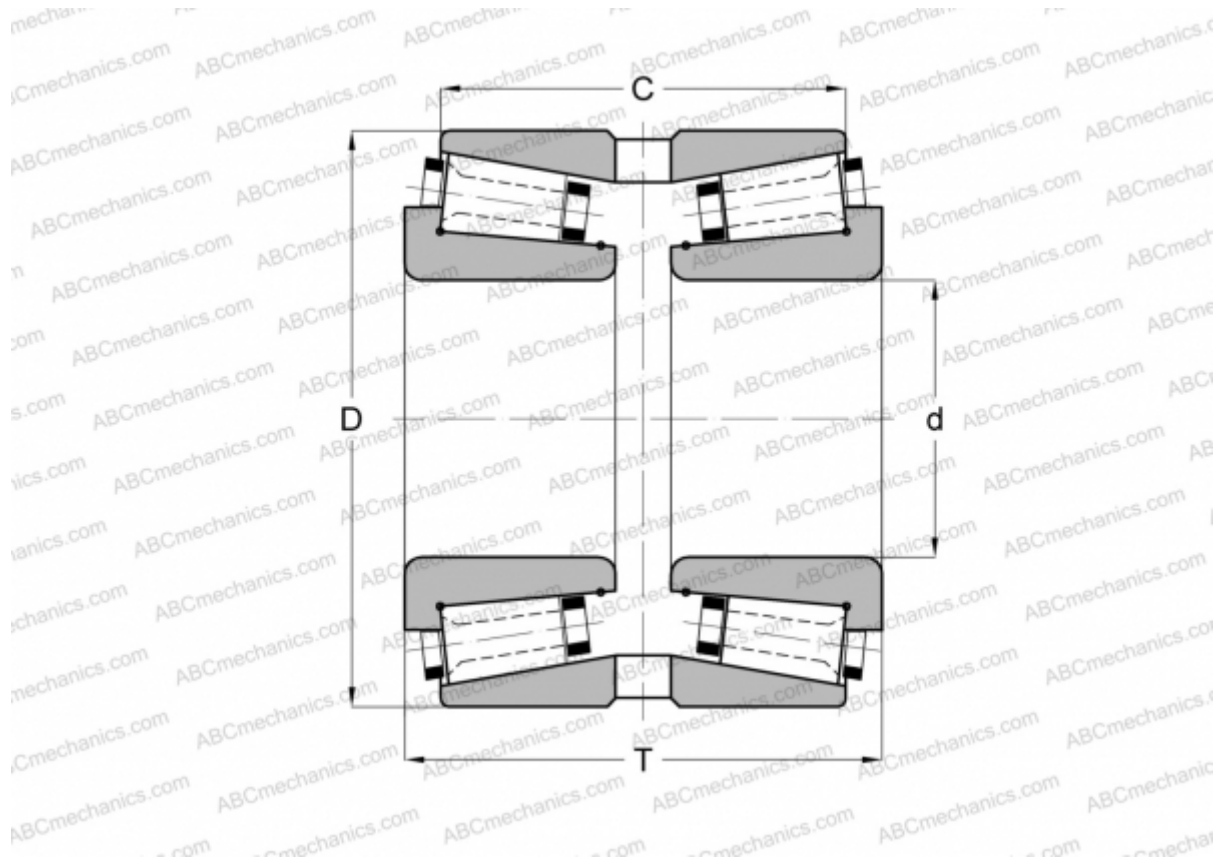

### Technical specification

#### DIMENSIONS, MM

d	33,338
D	68,000
T	52,000
C	42,480

**WEIGHT, KG** 0,780

**MANUFACTURER** [GAMET](#)