

101041X/101076G GAMET

Tapered roller bearings

TYPE: Roller bearings, Tapered, Precision, GAMET type G, double-row

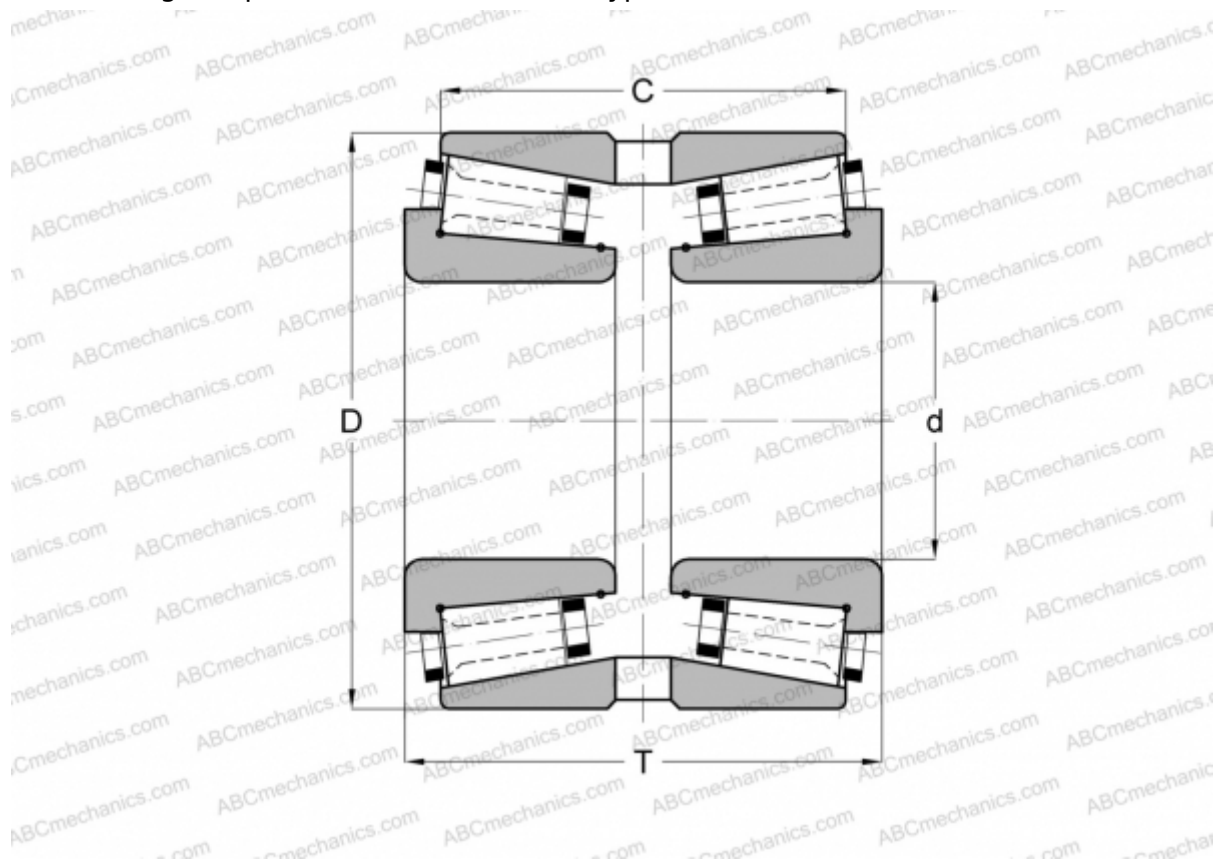

Technical specification

DIMENSIONS, MM

d	41,275
D	76,000
T	57,000
C	45,500

WEIGHT, KG 0,850

MANUFACTURER [GAMET](#)