

111044X/111090G GAMET

Tapered roller bearings

TYPE: Roller bearings, Tapered, Precision, GAMET type G, double-row

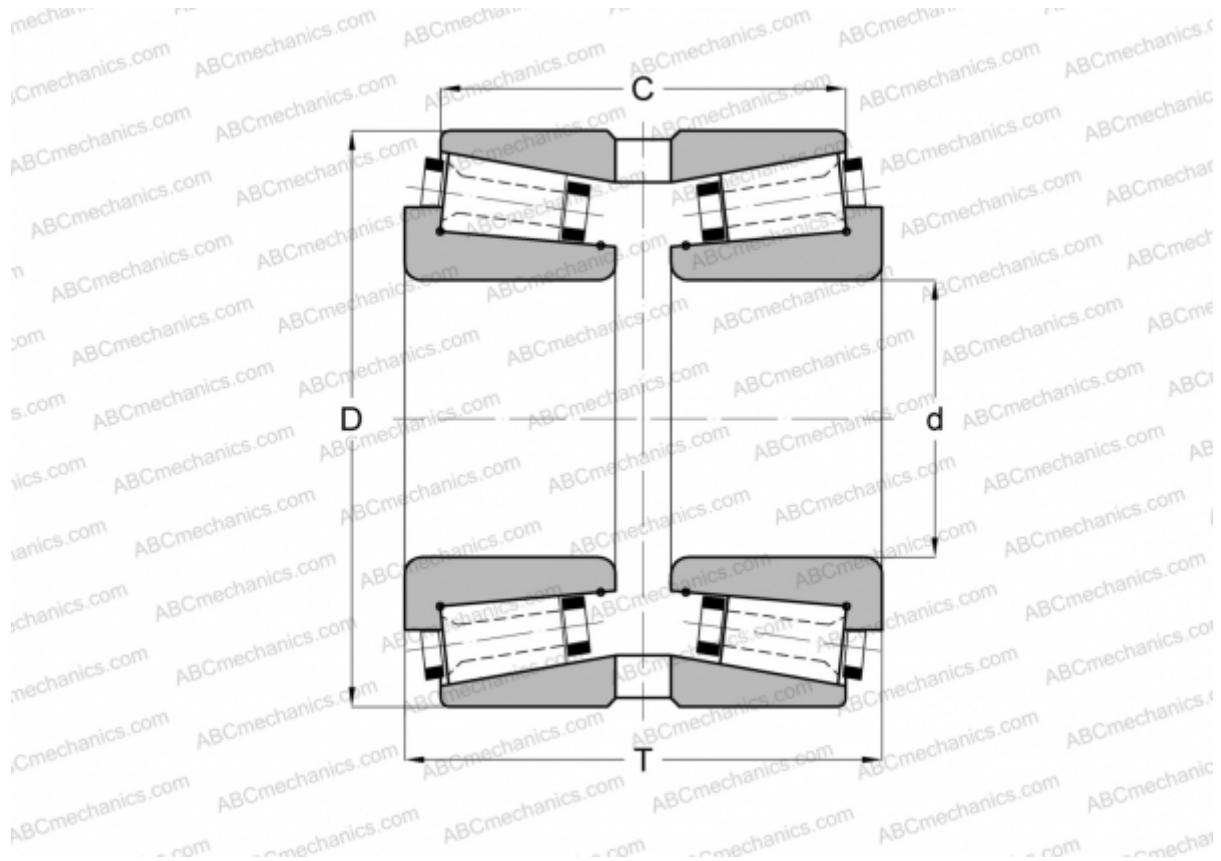

Technical specification

DIMENSIONS, MM

d	44,450
D	90,000
T	64,000
C	51,300

WEIGHT, KG 1,330

MANUFACTURER [GAMET](#)