

112045/112085G GAMET

Tapered roller bearings

TYPE: Roller bearings, Tapered, Precision, GAMET type G, double-row

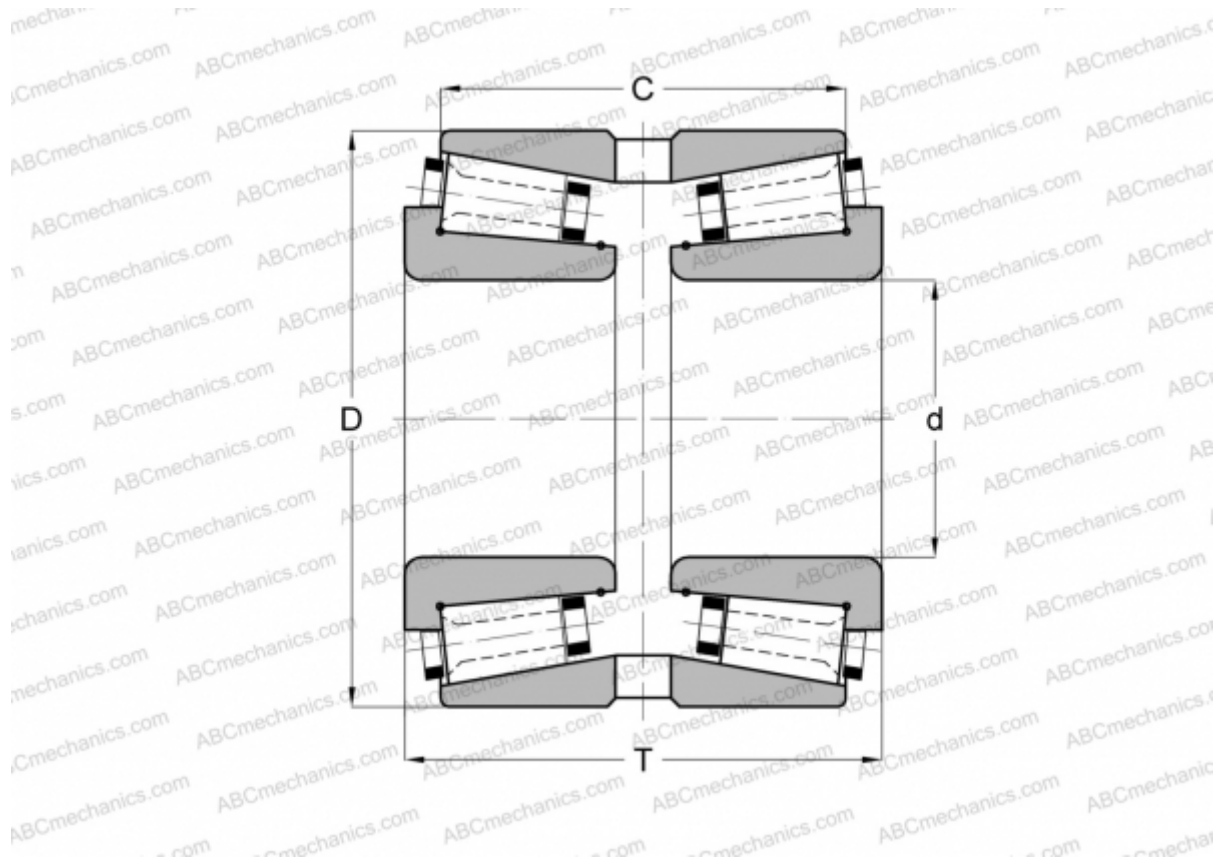

Technical specification

DIMENSIONS, MM

d	45,000
D	85,000
T	55,000
C	48,660

WEIGHT, KG 1,070

MANUFACTURER [GAMET](#)