

119045/119085G GAMET

Tapered roller bearings

TYPE: Roller bearings, Tapered, Precision, GAMET type G, double-row

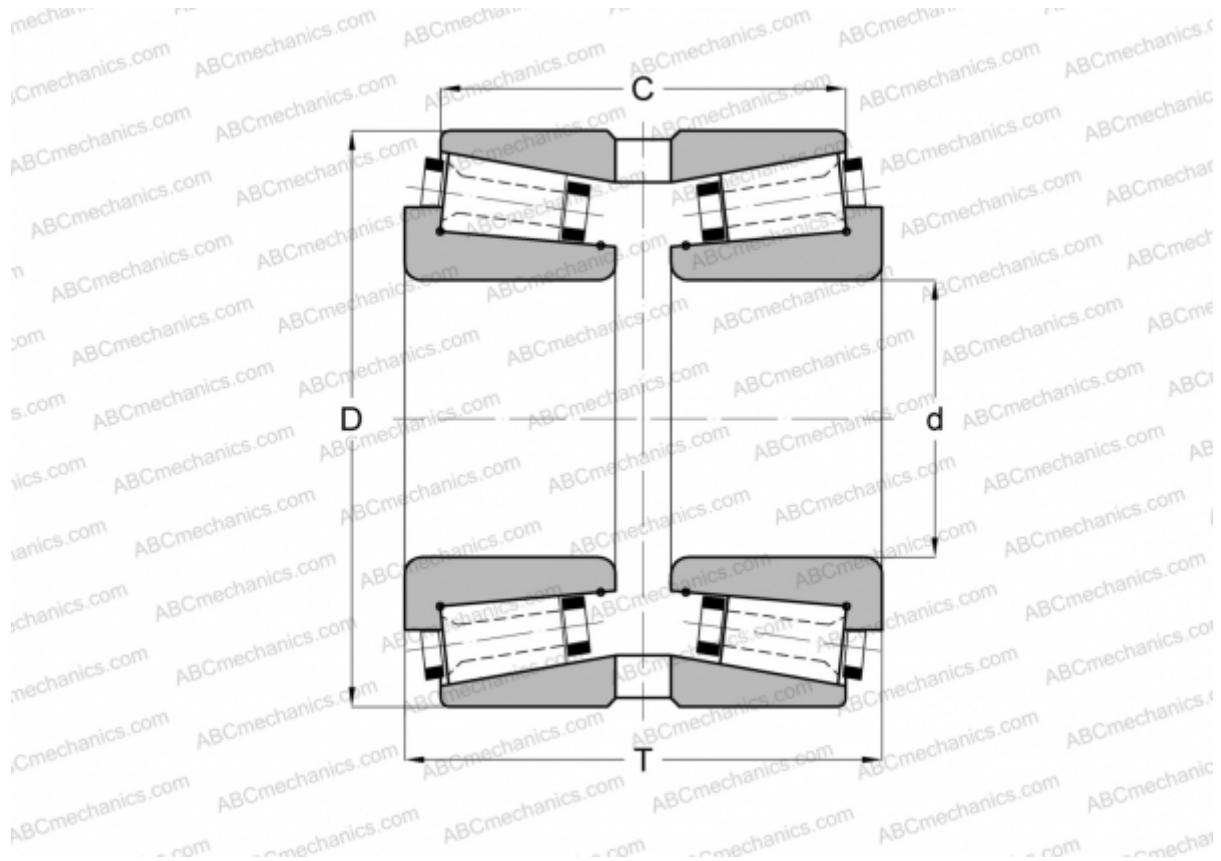

Technical specification

DIMENSIONS, MM

d	45,000
D	85,000
T	62,000
C	55,660

WEIGHT, KG 1,170

MANUFACTURER [GAMET](#)