

110057X/110098XG GAMET

Tapered roller bearings

TYPE: Roller bearings, Tapered, Precision, GAMET type G, double-row

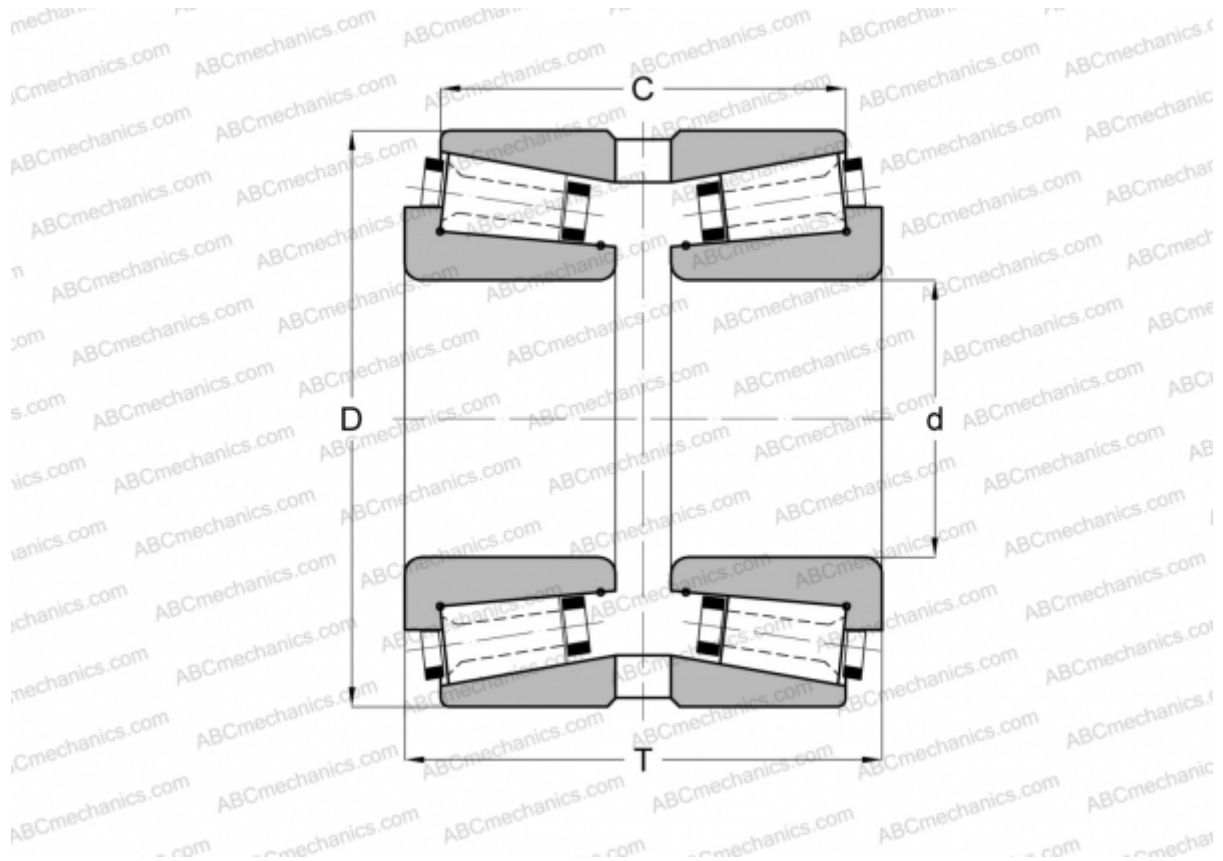

Technical specification

DIMENSIONS, MM

d	57,150
D	98,425
T	65,000
C	54,000

WEIGHT, KG 1,945

MANUFACTURER [GAMET](#)