

130063X/130127G GAMET

Tapered roller bearings

TYPE: Roller bearings, Tapered, Precision, GAMET type G, double-row

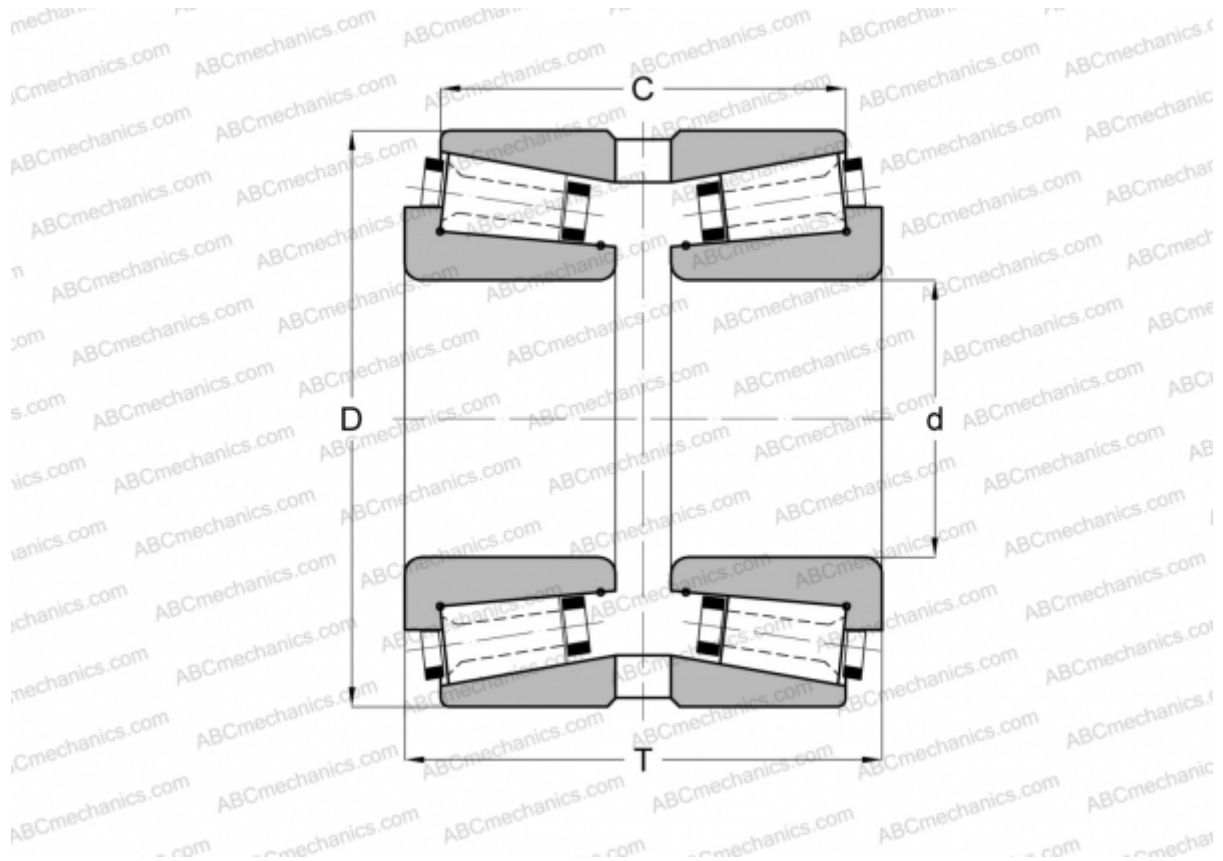

Technical specification

DIMENSIONS, MM

d	63,500
D	127,000
T	71,000
C	59,880

WEIGHT, KG 2,860

MANUFACTURER [GAMET](#)