

210095/210170G GAMET

Tapered roller bearings

TYPE: Roller bearings, Tapered, Precision, GAMET type G, double-row

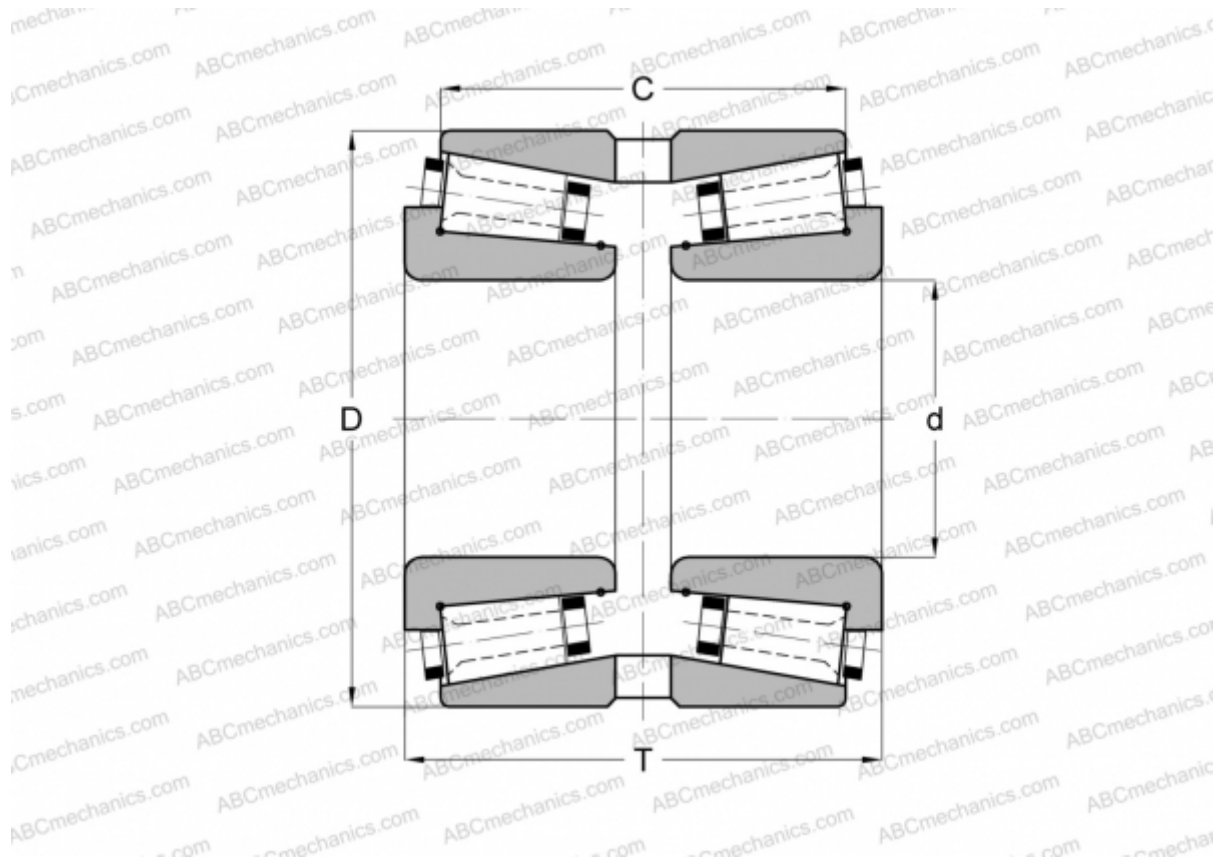

Technical specification

DIMENSIONS, MM

d	95,000
D	170,000
T	106,000
C	89,000

WEIGHT, KG 8,345

MANUFACTURER [GAMET](#)