

184120/184200G GAMET

Tapered roller bearings

TYPE: Roller bearings, Tapered, Precision, GAMET type G, double-row

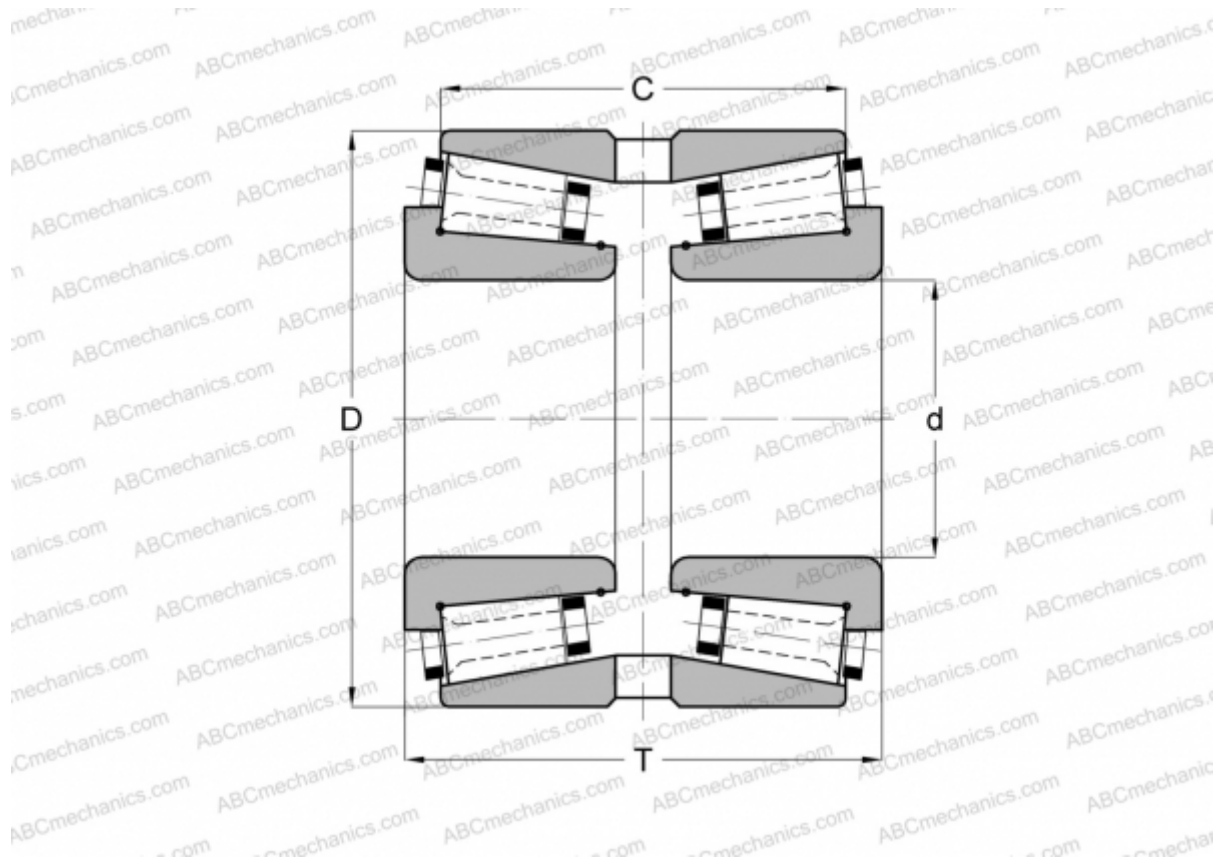

Technical specification

DIMENSIONS, MM

d	120,000
D	200,000
T	108,000
C	82,600

WEIGHT, KG 8,460

MANUFACTURER [GAMET](#)