

183152X/183222XG GAMET

Tapered roller bearings

TYPE: Roller bearings, Tapered, Precision, GAMET type G, double-row

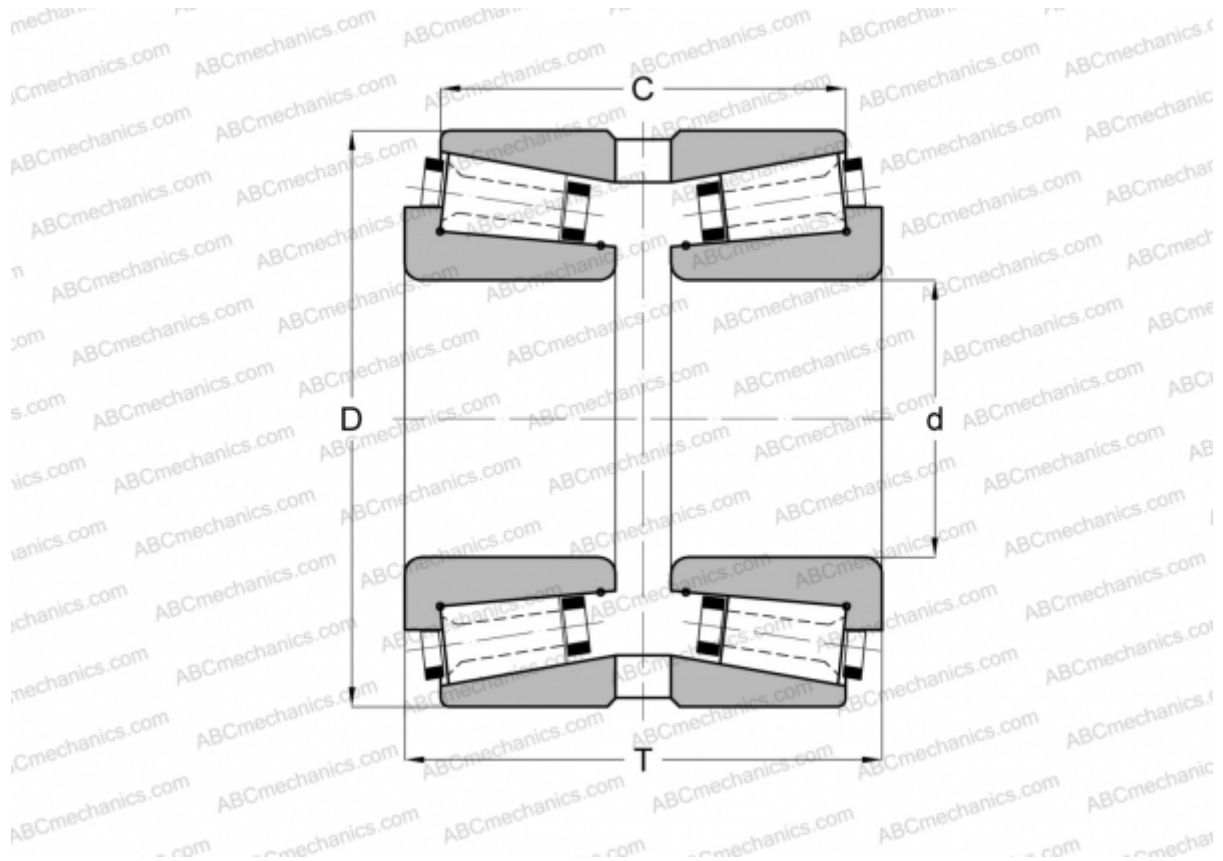

Technical specification

DIMENSIONS, MM

d	152,400
D	222,250
T	105,000
C	81,200

WEIGHT, KG 10,730

MANUFACTURER [GAMET](#)