

100031X/100072H GAMET

Tapered roller bearings

TYPE: Roller bearings, Tapered, Precision, GAMET type H, double-row, flanged cup

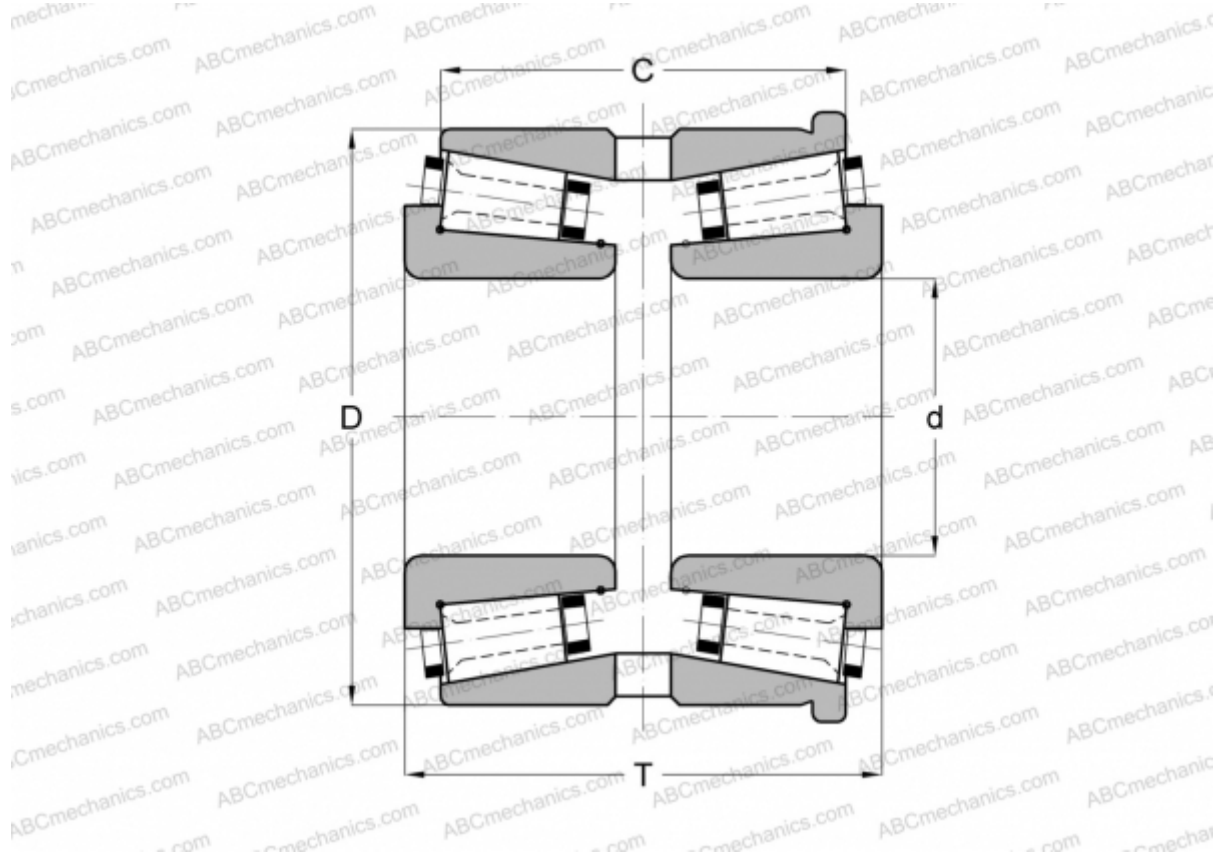

Technical specification

DIMENSIONS, MM

d	31,750
D	72,000
T	57,000
C	46,500

WEIGHT, KG 0,860

MANUFACTURER [GAMET](#)