

## 112045/112085H GAMET

Tapered roller bearings

TYPE: Roller bearings, Tapered, Precision, GAMET type H, double-row, flanged cup

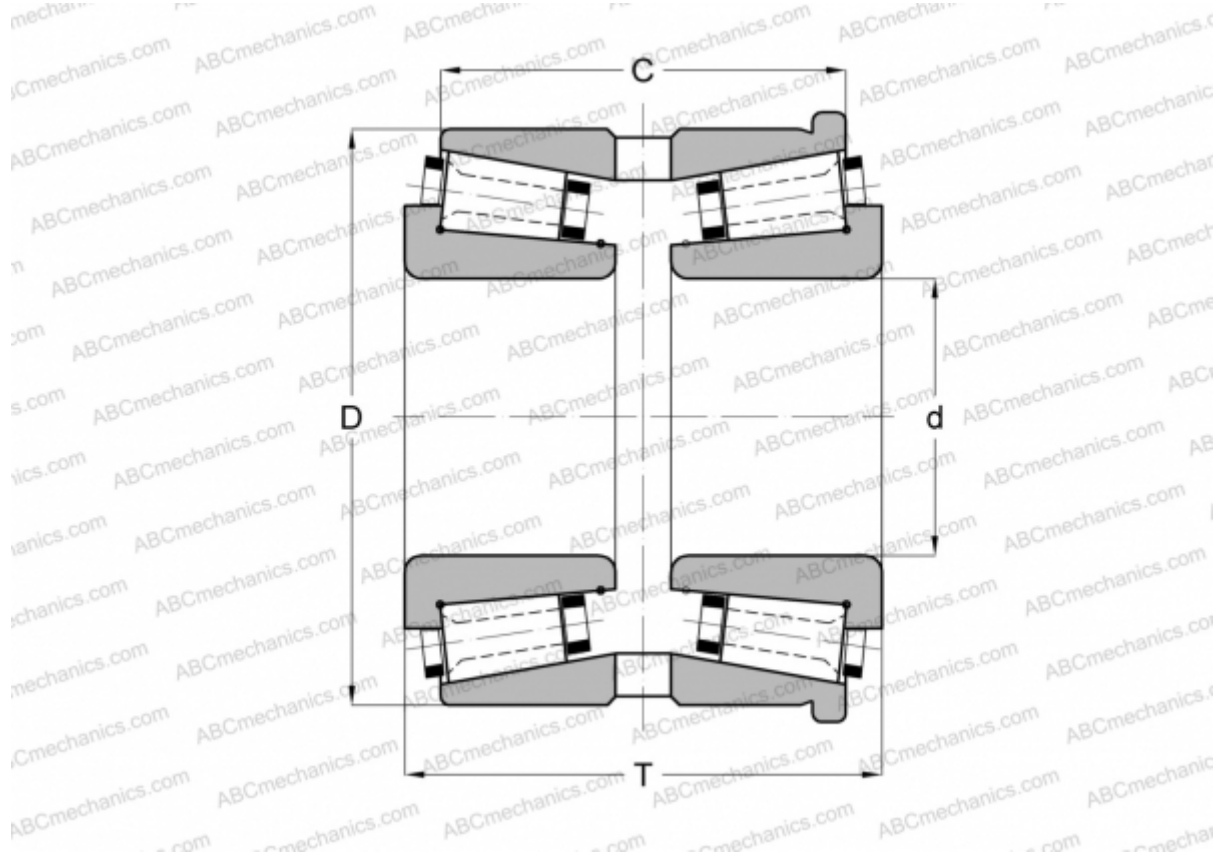

### Technical specification

#### DIMENSIONS, MM

d	45,000
D	85,000
T	55,000
C	48,660

**WEIGHT, KG** 1,110

**MANUFACTURER** [GAMET](#)