

119045/119085H GAMET

Tapered roller bearings

TYPE: Roller bearings, Tapered, Precision, GAMET type H, double-row, flanged cup

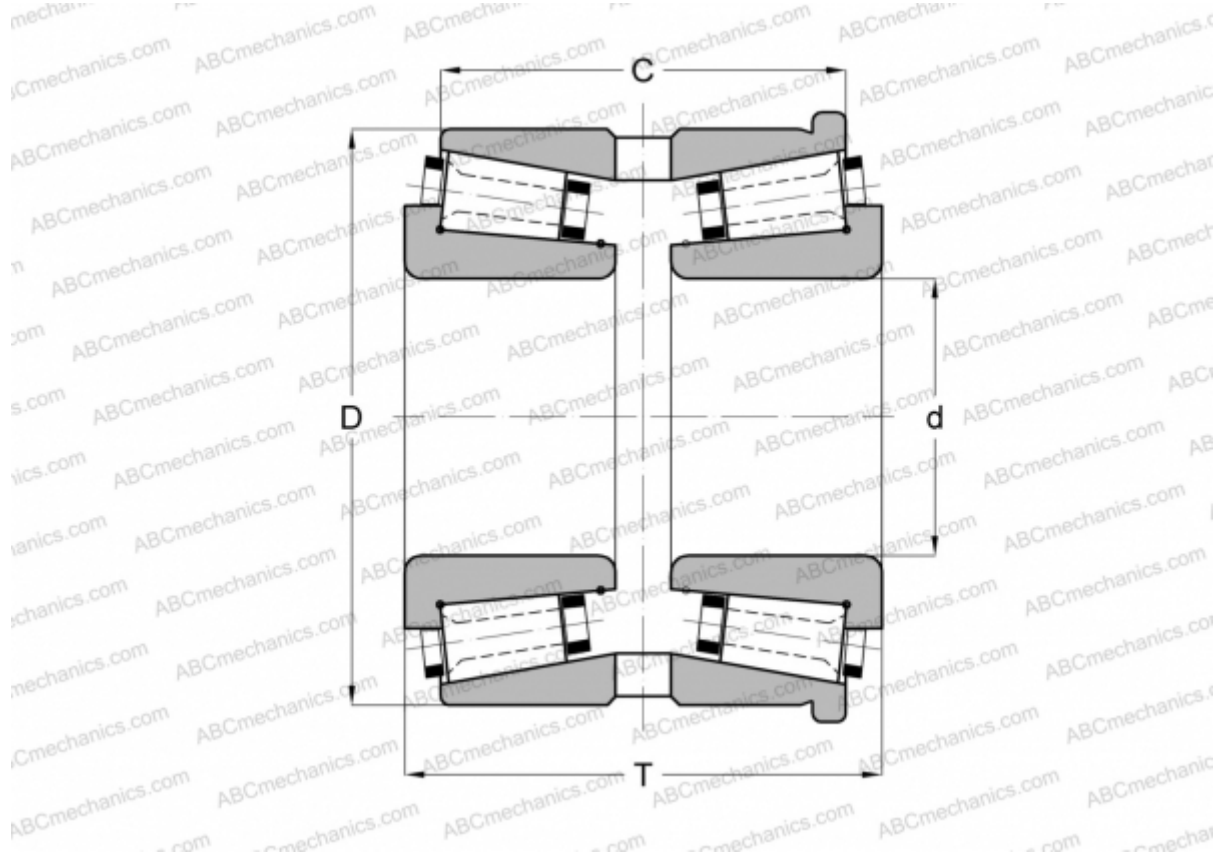

Technical specification

DIMENSIONS, MM

d	45,000
D	85,000
T	62,000
C	55,660

WEIGHT, KG 1,190

MANUFACTURER [GAMET](#)