

110050/110096XH GAMET

Tapered roller bearings

TYPE: Roller bearings, Tapered, Precision, GAMET type H, double-row, flanged cup

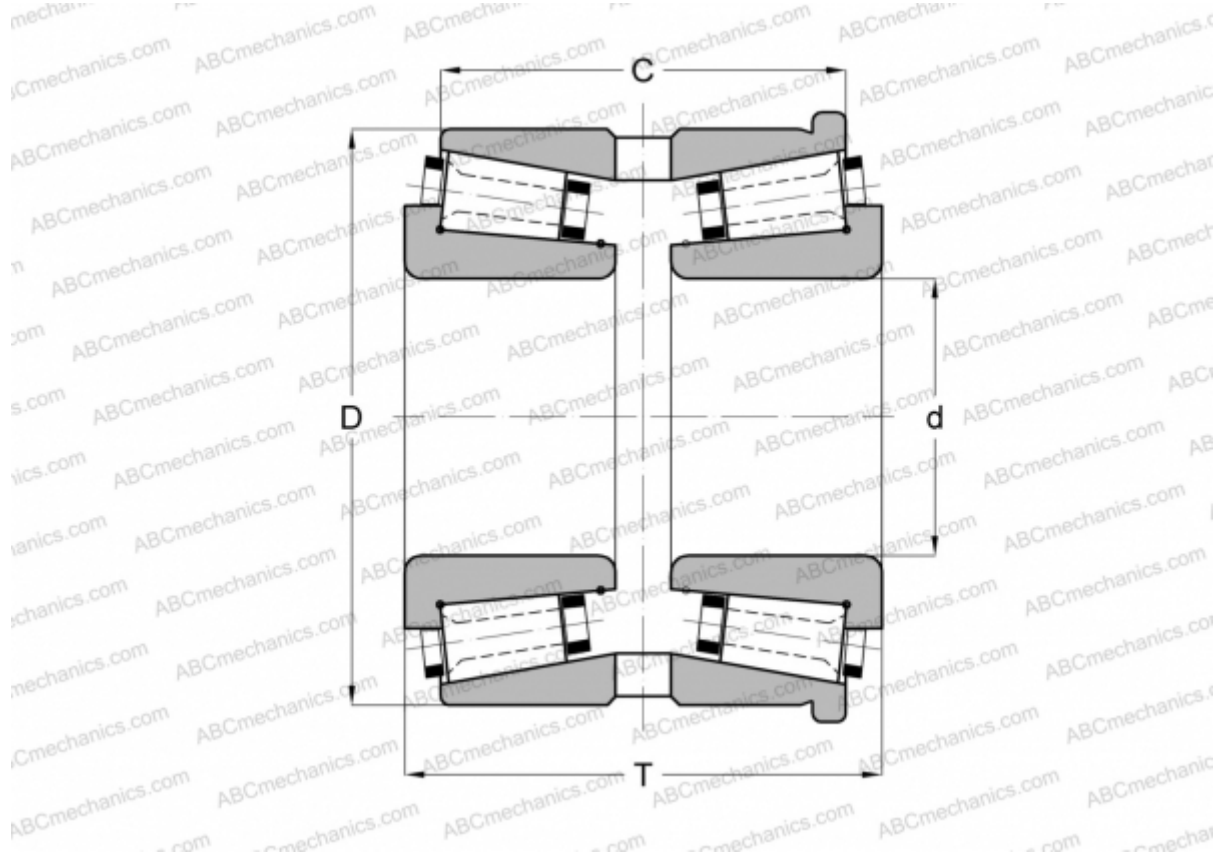

Technical specification

DIMENSIONS, MM

d	50,000
D	96,838
T	65,000
C	54,000

WEIGHT, KG 2,005

MANUFACTURER [GAMET](#)