

110055/110100H GAMET

Tapered roller bearings

TYPE: Roller bearings, Tapered, Precision, GAMET type H, double-row, flanged cup

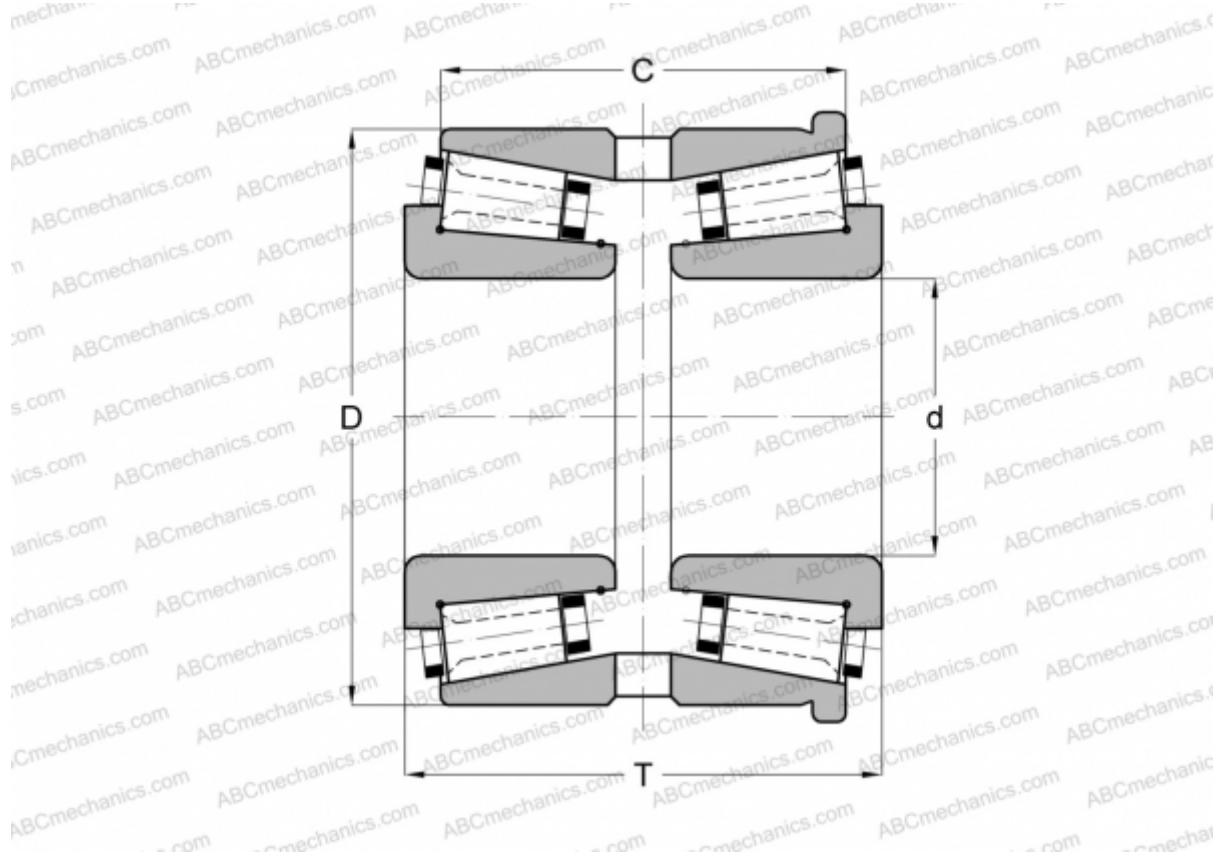

Technical specification

DIMENSIONS, MM

d	55,000
D	100,000
T	65,000
C	54,000

WEIGHT, KG 1,825

MANUFACTURER [GAMET](#)