

113060/113101XH GAMET

Tapered roller bearings

TYPE: Roller bearings, Tapered, Precision, GAMET type H, double-row, flanged cup

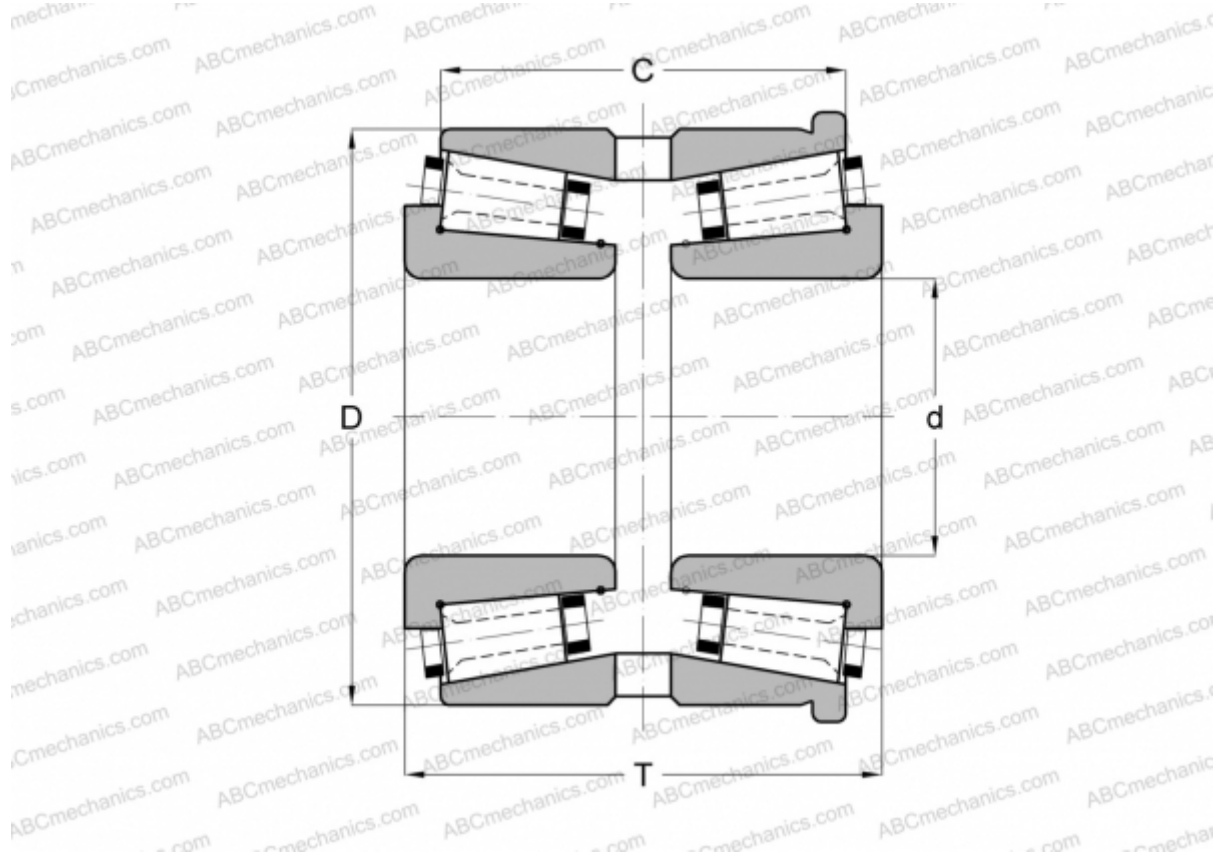

Technical specification

DIMENSIONS, MM

| | |
|---|---------|
| d | 60,000 |
| D | 101,600 |
| T | 58,000 |
| C | 46,880 |

WEIGHT, KG 1,900

MANUFACTURER [GAMET](#)