

## 120060/120112XH GAMET

Tapered roller bearings

TYPE: Roller bearings, Tapered, Precision, GAMET type H, double-row, flanged cup

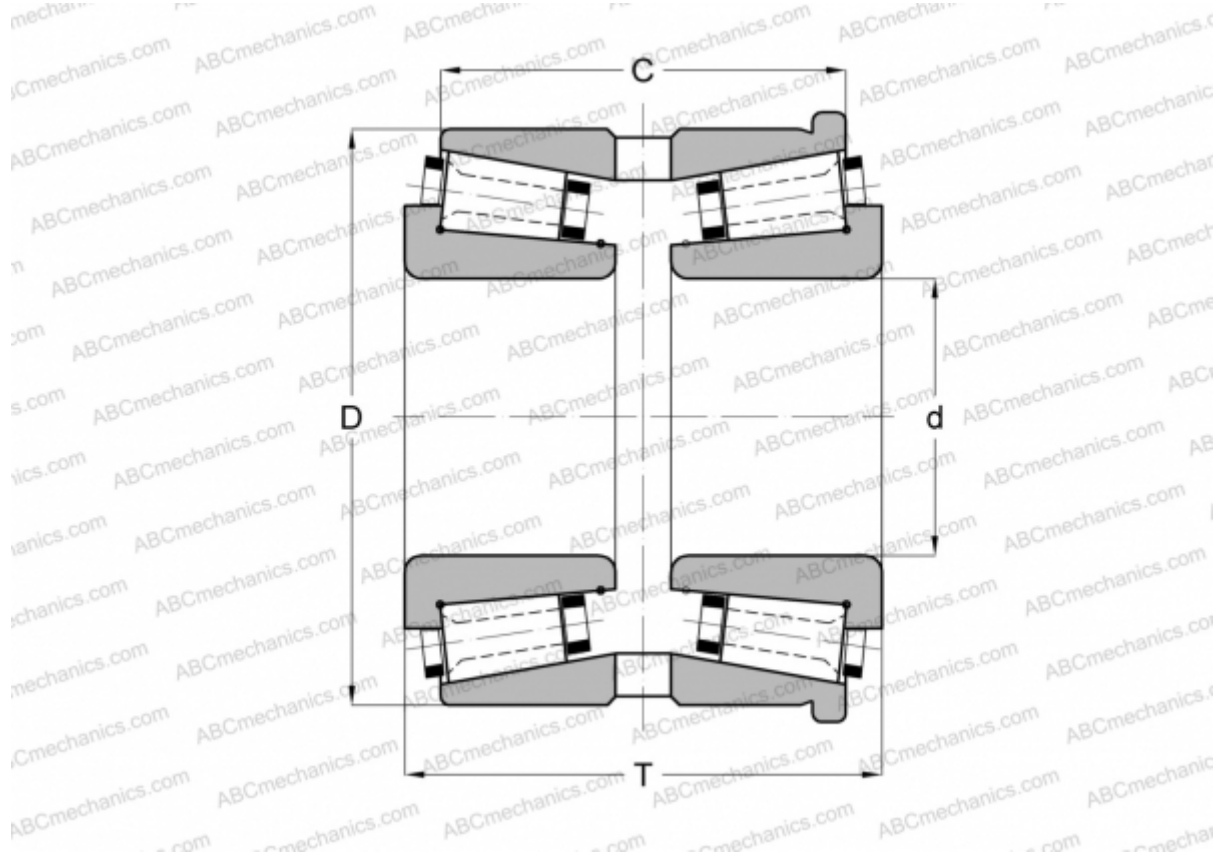

### Technical specification

#### DIMENSIONS, MM

d	60,000
D	112,712
T	73,000
C	60,300

**WEIGHT, KG** 2,470

**MANUFACTURER** [GAMET](#)