

130060/130120H GAMET

Tapered roller bearings

TYPE: Roller bearings, Tapered, Precision, GAMET type H, double-row, flanged cup

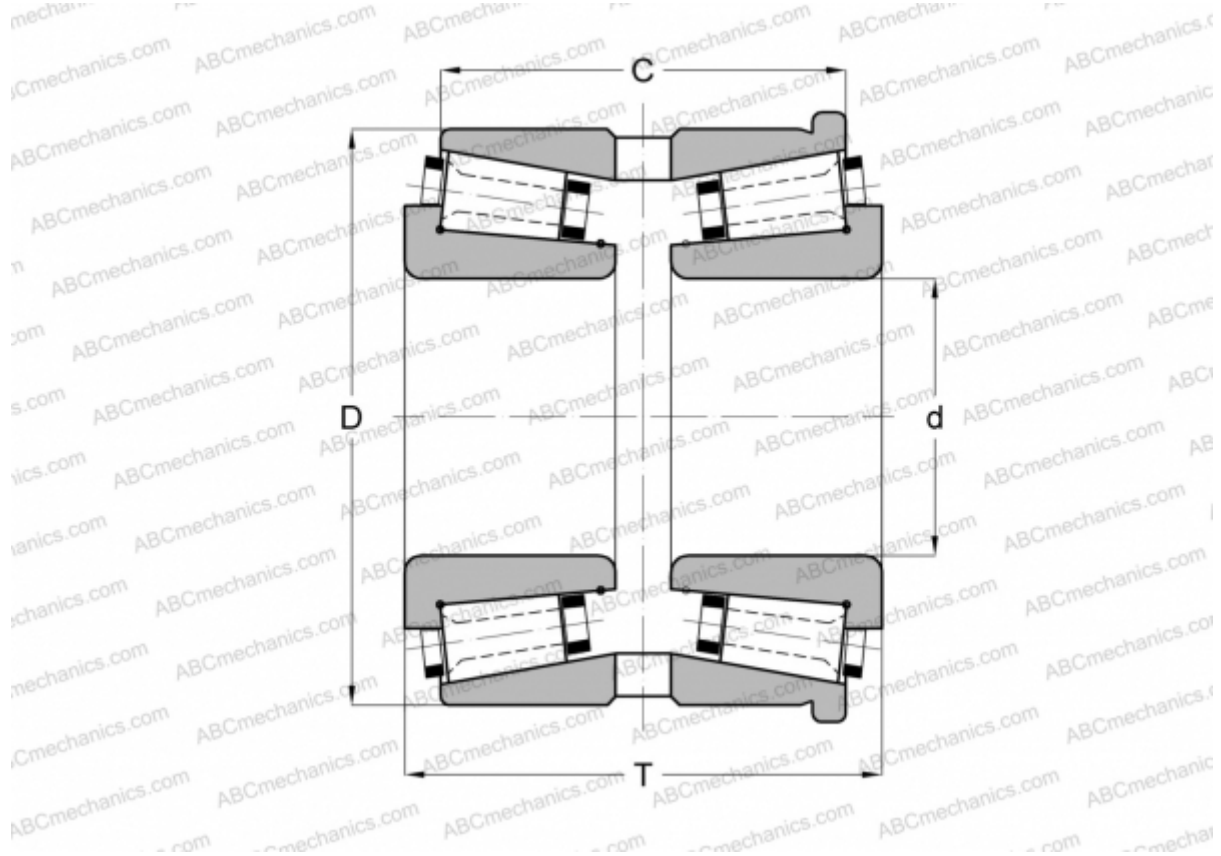

Technical specification

DIMENSIONS, MM

d	60,000
D	120,000
T	71,000
C	59,880

WEIGHT, KG 2,960

MANUFACTURER [GAMET](#)