

133075/133127H GAMET

Tapered roller bearings

TYPE: Roller bearings, Tapered, Precision, GAMET type H, double-row, flanged cup

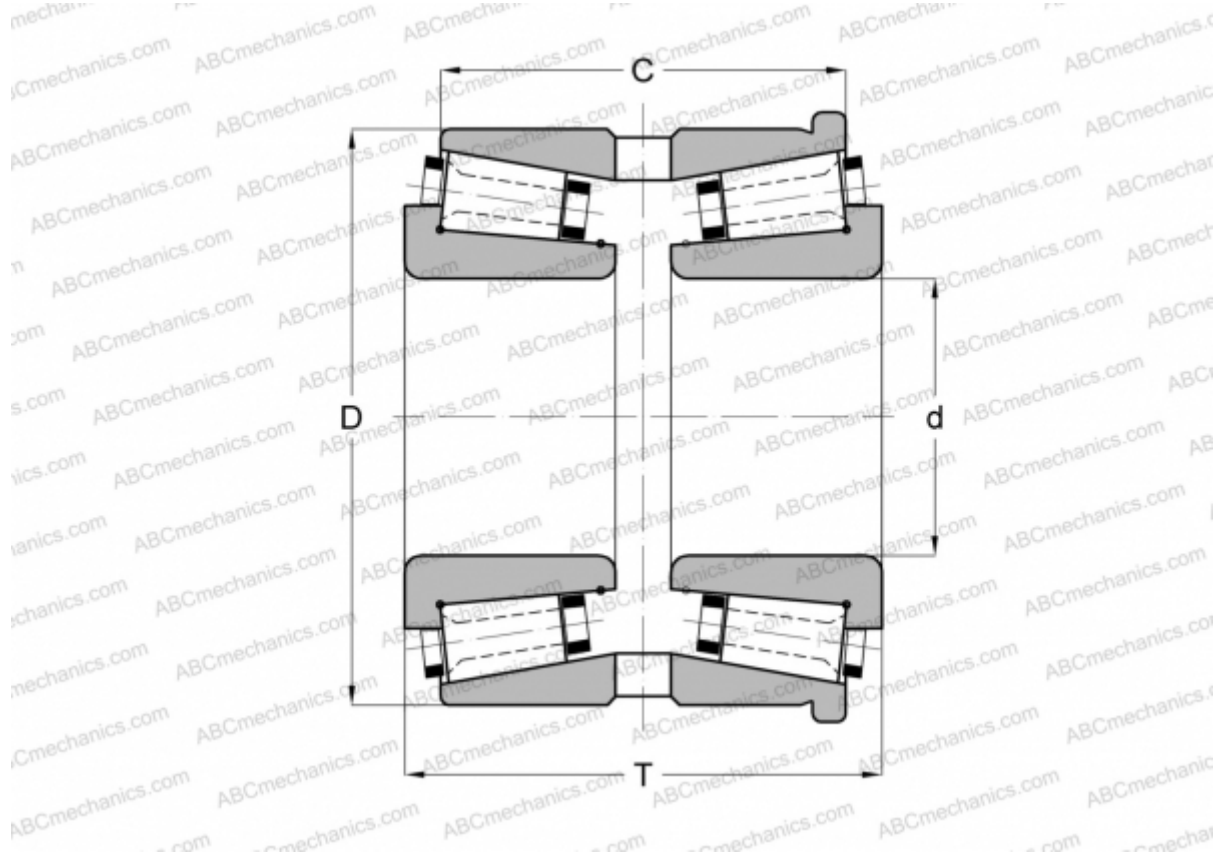

Technical specification

DIMENSIONS, MM

d	75,000
D	127,000
T	73,000
C	60,500

WEIGHT, KG 3,300

MANUFACTURER [GAMET](#)