

133076X/133133XH GAMET

Tapered roller bearings

TYPE: Roller bearings, Tapered, Precision, GAMET type H, double-row, flanged cup

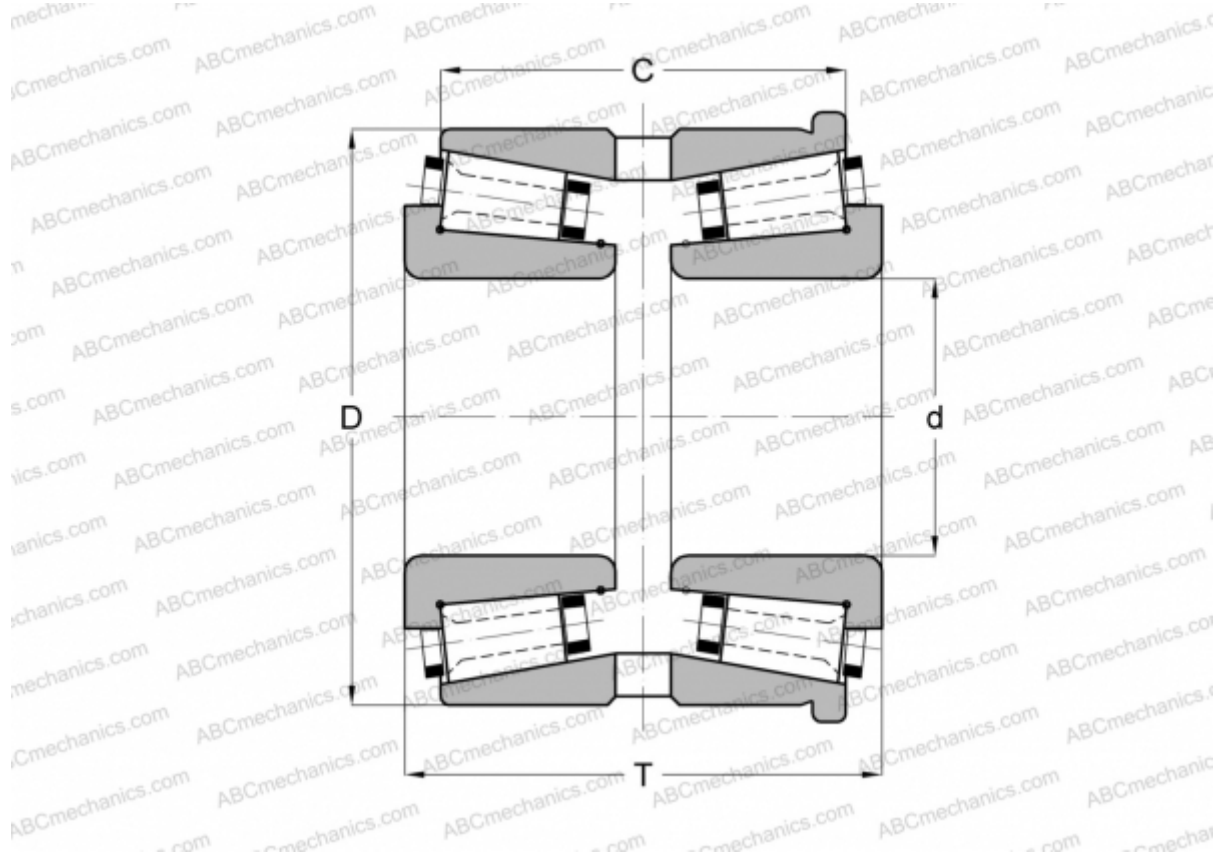

Technical specification

DIMENSIONS, MM

d	76,200
D	133,350
T	73,000
C	60,500

WEIGHT, KG 3,300

MANUFACTURER [GAMET](#)