

140082X/140140H GAMET

Tapered roller bearings

TYPE: Roller bearings, Tapered, Precision, GAMET type H, double-row, flanged cup

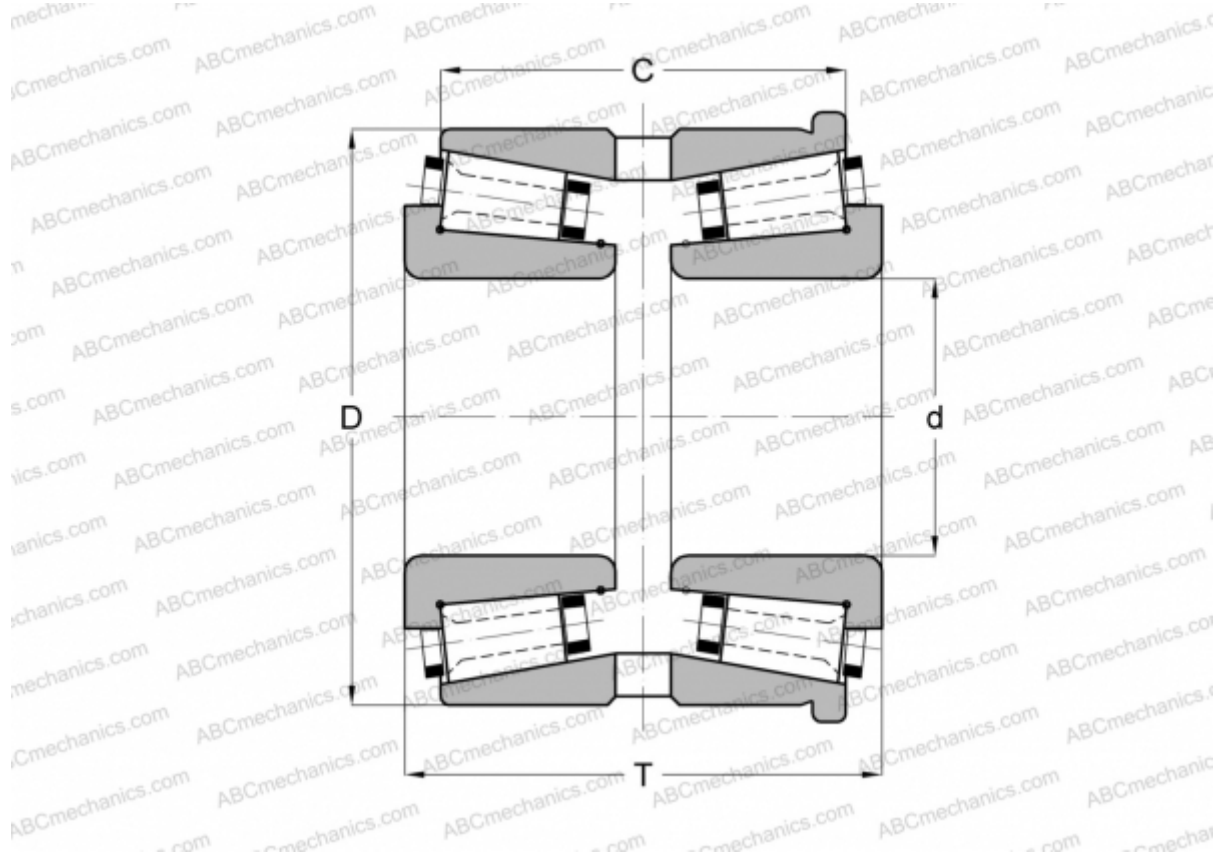

Technical specification

DIMENSIONS, MM

d	82,550
D	140,000
T	85,000
C	69,140

WEIGHT, KG 4,345

MANUFACTURER [GAMET](#)