

210090/210170H GAMET

Tapered roller bearings

TYPE: Roller bearings, Tapered, Precision, GAMET type H, double-row, flanged cup

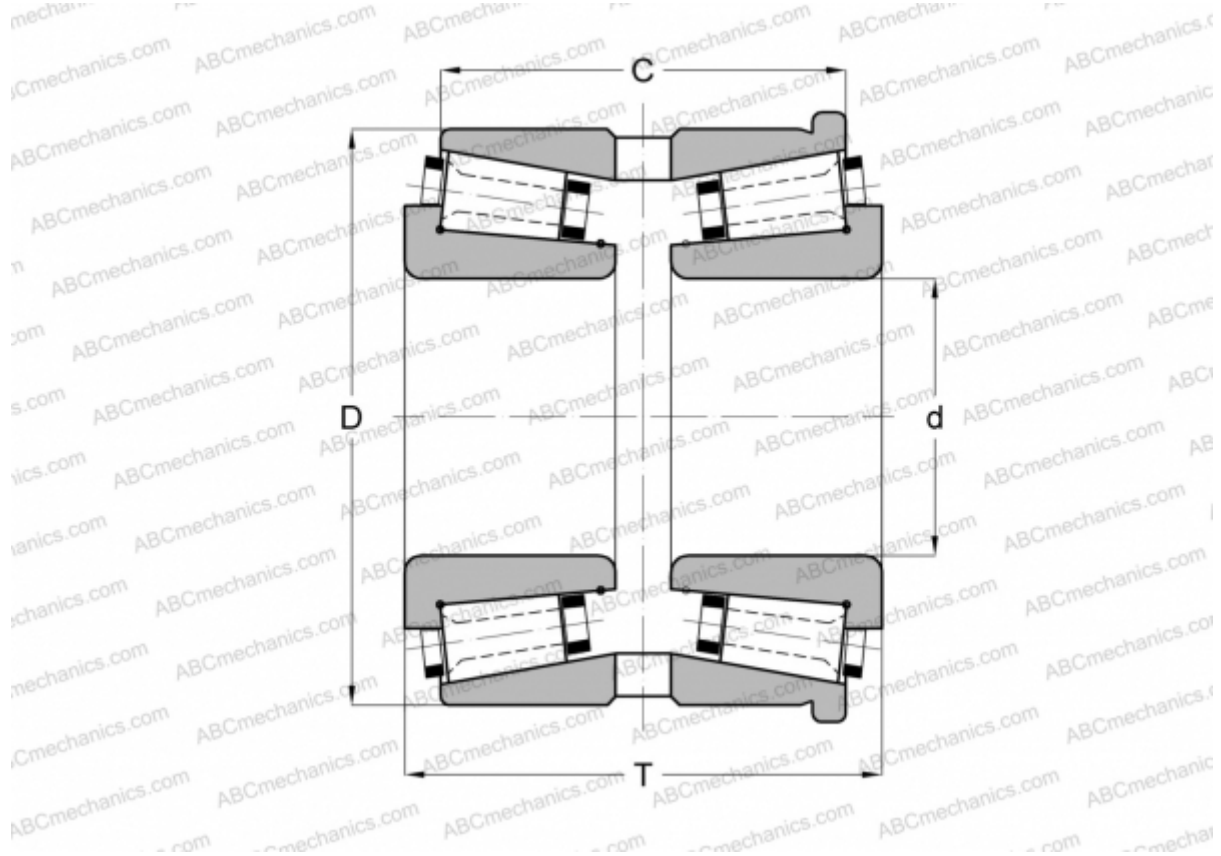

Technical specification

DIMENSIONS, MM

d	90,000
D	170,000
T	106,000
C	89,000

WEIGHT, KG 8,545

MANUFACTURER [GAMET](#)