

131097/131150H GAMET

Tapered roller bearings

TYPE: Roller bearings, Tapered, Precision, GAMET type H, double-row, flanged cup

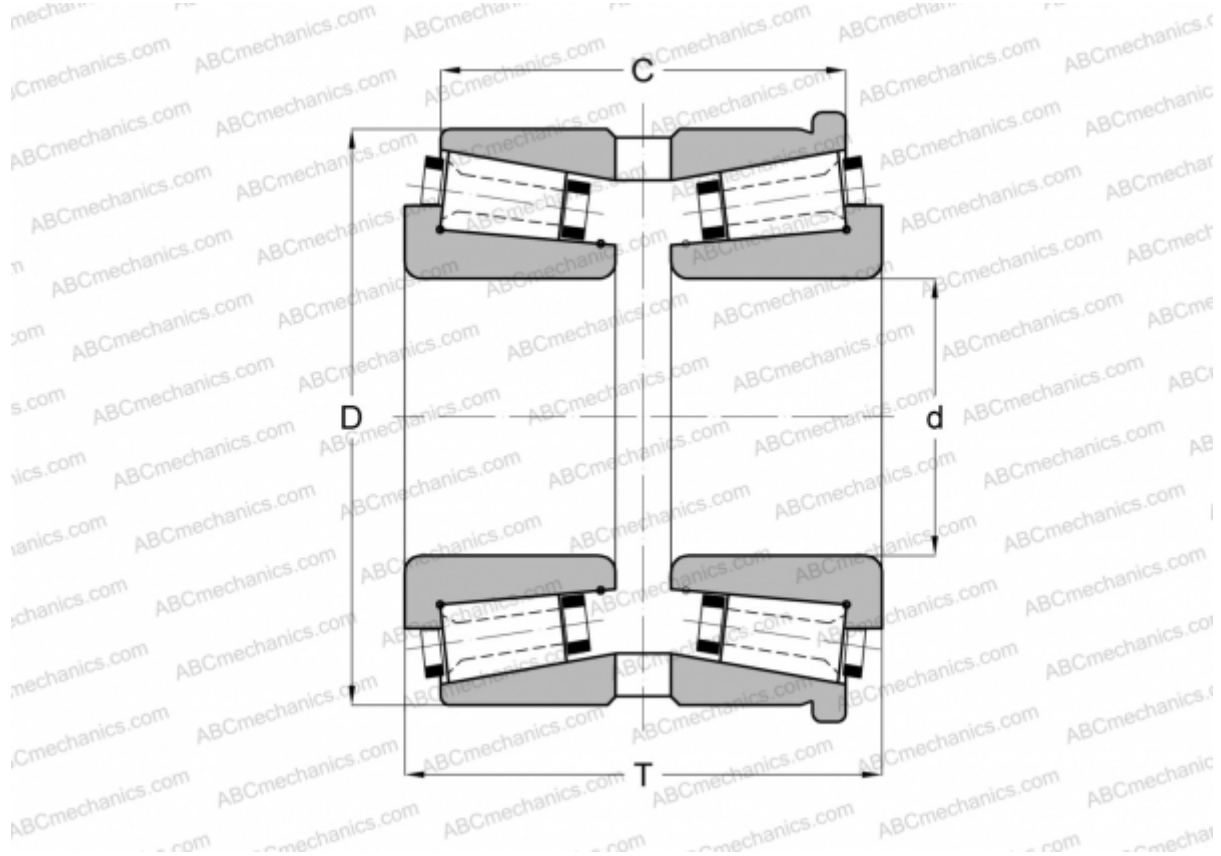

Technical specification

DIMENSIONS, MM

d	97,000
D	150,000
T	75,000
C	62,000

WEIGHT, KG 4,745

MANUFACTURER [GAMET](#)