

180105/180180XH GAMET

Tapered roller bearings

TYPE: Roller bearings, Tapered, Precision, GAMET type H, double-row, flanged cup

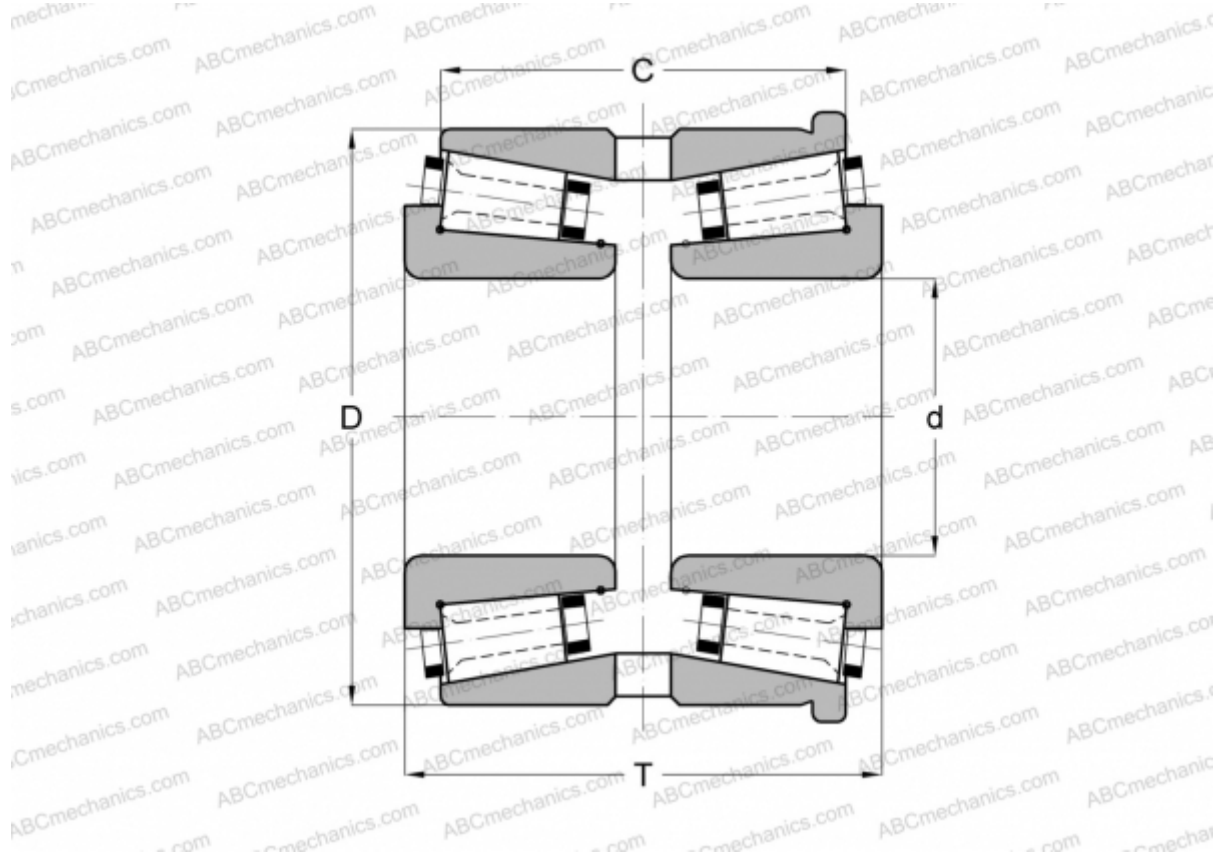

Technical specification

DIMENSIONS, MM

d	105,000
D	180,975
T	100,000
C	84,000

WEIGHT, KG 9,060

MANUFACTURER [GAMET](#)